

HITACHI

USER'S MANUAL

OPTION

J.NET-INT

(LQE545)

S10mini

SIOV

USER'S MANUAL

OPTION

J.NET-INT

(LQE545)

S10mini

SIOV

First Edition, September 2003, SVE-1-107(D) (out of print)
Second Edition, December 2005, SVE-1-107(E) (out of print)
Third Edition, November 2006, SVE-1-107(F) (out of print)
Fourth Edition, September 2008, SVE-1-107(G) (out of print)
Fifth Edition, January 2013, SVE-1-107(H)

All Rights Reserved, Copyright © 2003, 2013, Hitachi, Ltd.

The contents of this publication may be revised without prior notice.

No part of this publication may be reproduced in any form or by any means without permission in writing from the publisher.

Printed in Japan.

BI<IC> (FL-MW2007, AI10)

SAFETY PRECAUTIONS

- Before installation, operation, maintenance, and/or inspection of this product, be sure to read through carefully this manual and other related manuals. Do not use this product until you are familiar with all the information concerning this product, safety information, and precautions provided in those manuals.
- Keep this manual in a readily accessible place so that users of this product may easily reach it.
- This manual contains information on potential hazards that is intended as a guide for safe use of this product. The potential hazards listed in the manual are divided into four hazard levels of danger, warning, caution, and notice, according to the level of their severity. The following are definitions of the safety labels containing the corresponding signal words DANGER, WARNING, CAUTION, and NOTICE.



: This safety label identifies precautions that, if not heeded, will result in death or serious injury.





: Identifies precautions that, if not heeded, could result in death or serious injury.



: Identifies precautions that, if not heeded, could result in minor or moderate injury.



: This safety label without a safety alert symbol identifies precautions that, if not heeded, could result in property damage or loss not related to personal injury.

Failure to observe any of the  and  statements used in this manual could also lead to a serious consequence, depending on the situation in which this product is used. Therefore, be sure to observe all of those statements without fail.

The following are definitions of the phrases “serious injury,” “minor or moderate injury,” and “property damage or loss not related to personal injury” used in the above definitions of the safety labels.

Serious injury: Is an injury that requires hospitalization for medical treatment, has aftereffects, and/or requires long-term follow-up care. Examples of serious injuries are as follows: vision loss, burn (caused by dry heat or extreme cold), electric-shock injury, broken bone, poisoning, etc.

Minor or moderate injury: Is an injury that does not require either hospitalization for medical treatment or long-term follow-up care. Examples of minor or moderate injuries are as follows: burn, electric-shock injury, etc.

Property damage or loss not related to personal injury: Is a damage to or loss of personal property. Examples of property damages or losses not related to personal injury are as follows: damage to this product or other equipment or their breakdown, loss of useful data, etc.

The safety precautions stated in this manual are based on the general rules of safety applicable to this product. These safety precautions are a necessary complement to the various safety measures included in this product. Although they have been planned carefully, the safety precautions posted on this product and in the manual do not cover every possible hazard. Common sense and caution must be used when operating this product. For safe operation and maintenance of this product, establish your own safety rules and regulations according to your unique needs. A variety of industry standards are available to establish such safety rules and regulations.

1. General Safety Guidelines

Before installing, operating inspecting or conducting maintenance on this unit, read the following instructions carefully:

- Follow all the operating procedures provided in this manual.
- Pay special attention to and follow all the hazard warnings on the machine and in the manual. Failure to do so can cause injury to yourself or damage to the machine.
- Do not perform any operation or action in any way other than as provided in this manual. When in doubt, call the designated field engineer. Keep in mind that the hazard warnings in this manual or on the machine cannot cover every possible case, as it is impossible to predict and evaluate all circumstances beforehand.
Be alert and use your common sense.
- Do not install, wire, handle, modify, or use maintenance parts in any manner not described in this manual. Such a practice may result in breakdown of this equipment or peripherals, injury or even death. Hitachi will not be responsible for any accident or failure resulting from such mishandling.

Read the following safety guidelines carefully and follow them when you conduct maintenance of the machine.

Before starting maintenance

- Maintenance of the machine must be done only by trained and qualified field engineers.
- Read and follow the safety guidelines and procedures in this manual and the related manuals.
- In this manual and on the machine, hazard warnings are provided to aid you in preventing or reducing the risk of death, personal injury, or product damage. Understand and follow these hazard warnings fully.
- Keep in mind that the hazard warnings in this manual or on the machine cannot cover every possible case, as it is impossible to predict and evaluate all circumstances beforehand.
Be alert and use your common sense.

During work

- For each procedure, follow the given sequence of steps.
- Use the special tools and instruments, specified for the work in the manual or commercially available tools and instruments which fit the purpose.
- Use measurement instruments and powered tools which are properly calibrated or periodically inspected.
- Keep the maintenance area neat and tidy.
- Always put away parts, materials or tools when not in use.
- Wear an eye protector where anything may fly about.
- When using sharp objects or cutting tools, make sure that no part of your body lies in the path of the blade bit, or point.
- Before finishing your work, make sure that all parts removed during maintenance have been installed back in their original positions in the machine.
Make sure that no tool or foreign material is left in the machine.

Prevention of electric shocks

- Before starting work, make sure that, unless otherwise specifically instructed, there is no potential electric hazard in the maintenance area such as insufficient grounding or a wet floor.
- Before starting work, note where the emergency power-off switches are located and make sure you know how to operate them.
- Unless otherwise specifically instructed, cut off all power sources to the machine before starting maintenance. Just switching off the machine power supplies is usually not enough.

When power is fed from a wall or floor outlet, unplug the power supply cord, or turn off the switch on the power distribution panel or board. Attach a notice on the panel or board prohibiting the use of the switch.

If the energy isolating device such as the switch on the power distribution panel or board accepts a lockout device, turn off the power, lock out the energy isolating device, and bring the key with you. When you take over the work and the key for the lockout device if applicable, do not assume that the power is off. Make sure yourself that the above-mentioned conditions such as switches are satisfied. If necessary, use a measurement tool to ensure that the power is off.

- Do not touch any uninsulated conductor or surface, where so instructed, which remains charged for a limited time after the external power supply to the machine is disconnected.
- When working on a machine which has a grounding terminal, make sure that the terminal is properly connected to the facility's ground.
- When working close to a hazardously energized part, do not work alone; work with another person who can immediately turn off the power in an emergency.
- Do not wear any metallic item such as a wrist watch with a metallic surface, or metallic accessories.

If you wear eyeglasses with a metallic frame, take care not to let the frame touch an uninsulated surface.

- Make sure that your hands and arms are dry.
- Unless otherwise specifically instructed, use only one hand when it is necessary to work near an exposed live electric circuit.

This prevents the completion of the circuit through your heart even if you accidentally touch the circuit.

- Do not use a dental mirror near an exposed live electric circuit.

The mirror surface is conductive and can become hazardous even if it is made of plastic.

- Unless otherwise specifically instructed, do not supply power to any subassembly such as a power supply unit or a motor while it is removed from the machine.

Procedures in an emergency

For electric shock

- Do not panic. Do not become another victim through contact with the injured person.
- First, shut off the electric current passing through the victim.
Use the emergency power-off switch, if there is one, or, otherwise, a normal power-off switch. If this cannot be done, push the victim away from the source of the electric current by using a nonconductive object such as a dry wooden stick.
- Then, call an ambulance.
- If the victim is unconscious, artificial respiration may be necessary.
A proper method for performing artificial respiration or resuscitation should be learned beforehand. If the victim's heart is not beating, cardio-pulmonary resuscitation should be performed by a trained and qualified person.

For outbreak of fire

- First, shut off all the power from the machine using the emergency power-off switch, if there is one, or the normal power-off switch.
- If the fire continues burning after the power is shut off, take suitable actions including the use of a fire extinguisher or a call for the fire department.

2. Hazard Warning Statements

The following are the hazard warning statements contained in this manual.

2.1 WARNING Statement

(chapter 3, page 3-5)

 WARNING
<ul style="list-style-type: none">● Switch off the power supply before making connections to the terminal block. Making connections with the power supply being switched on may incur electrical shock hazards.● Electric shock hazards exist so that you might suffer burns or become electrocuted. Further, the system might malfunction due to noise interference. Therefore, ground the line ground (LG), frame ground (FG), and shield wire (SHD).

2.2 NOTICE Statements

(chapter 1, page 1-4)

NOTICE
Users of this product must have an adequate knowledge of the Windows® environment and user interface. This system conforms to the Windows® standard. This manual is prepared for users who are familiar with the basic Windows® operating procedures.

(chapter 2, page 2-3)

NOTICE
Switch off the power supply before operating the module number setting switch and bit rate setting switch. If you operate while the power supply is applied, it may result in a malfunction.

(chapter 3, page 3-2)

NOTICE

- With the S10mini series, mount the option module at the leftmost positions without an intervening space from the CPU module. Further, leave no open slots between option modules mounted.
- The S10V series places no limitations on the mounting location and available slots.
- If the J.NET-INT module is to be used in conjunction with an LPU module and handlers are to be started with a C-mode program, the J.NET-INT module must be mounted in a pair with a CMU module.

(chapter 3, page 3-3)

NOTICE

- Dust or other foreign matter might accumulate on the connector, resulting in poor contact. Immediately after the module is unpacked, perform the mounting and wiring procedures.
- To prevent the module from being damaged, observe the following precautions when you mount or demount the module:
 - Before mounting the module to the mount base connector, check that the connector pins are properly aligned and not bent, broken, or soiled with dirt or the like.
 - Ensure that the module is parallel to the mount base vertical surface as shown below when mounting. If you connect a module to or disconnect it from its connector while it is tilted, the connector pins may become damaged.
 - If the mount base is positioned overhead due to the employed enclosure structure, use a stepladder or the like and mount the module squarely. If you mount the module obliquely, the connector may become damaged.

(chapter 3, page 3-5)

NOTICE

- Insulate the mount base from the enclosure. To keep the mount base insulated, avoid removing the insulation sheets that are supplied with the mount base.
- The LG is a ground terminal for power supply noise. The FG and SHD are ground terminals for the noise in the remote I/O communication module and other external interface lines. To avoid interference between the ground terminals, separately ground the LG and FG.

(chapter 3, page 3-7)

NOTICE

The two shield ground (SHD) terminals and the frame ground (FG) terminal are wired internally. Be sure to ground the FG terminal.

(chapter 4, page 4-2)

NOTICE

Before installing the S10mini J.NET system, be sure to exit all the currently open Windows® programs. Do not forget to exit anti-virus software and other memory-resident programs. If you install the S10mini J.NET system without exiting such programs, an error may occur during installation. If such an error occurs, first uninstall the S10mini J.NET system as directed in, “4.1.2 Uninstalling,” exit all the Windows® programs, and then install the S10mini J.NET system again.

(chapter 4, page 4-4)

NOTICE

- The S10V basic system is required for operating the S10V J.NET system. If it is not installed, you cannot install the S10V J.NET system.
- Before installing the S10V J.NET system, be sure to exit all the currently open Windows® programs. Do not forget to exit anti-virus software and other memory-resident programs. If you install the J.NET system without exiting such programs, an error may occur during installation. If such an error occurs, first uninstall the S10V J.NET system as directed in, “4.1.2 Uninstalling,” exit all the Windows® programs, and then install the S10V J.NET system again.

(chapter 4, page 4-5)

NOTICE

- If Windows® opens a window during the uninstall process to display the question “Remove Shared File?,” click the button to retain shared files.
- When you want to reinstall the J.NET system, be sure to perform an uninstall and then perform an install.

(chapter 4, page 4-10)

NOTICE

- The S10mini series does not support GP-IB. Do not select “GPIB” on the communication type selection window.
- The S10V series does not support GP-IB. “GPIB” is not displayed on the communication type selection window.

(chapter 4, page 4-23)

NOTICE

For S10mini, please confirm whether the extension memory corresponding to a set address is mounted when the address of the extension memory is set. The system performance might decrease when the extension memory corresponding to a set address is a unmounting, and mount it, please.

(chapter 5, page 5-4)

NOTICE

For S10mini, please confirm whether the extension memory corresponding to a set address is mounted when the address of the extension memory is set. The system performance might decrease when the extension memory corresponding to a set address is a unmounting, and mount it, please.

(chapter 5, page 5-10)

NOTICE

Before using an operation function, register it using the tool system. For information on how to register operation functions, see “4.2.9 Registering user operation functions (S10mini).” This function is not available on the [S10V] J.NET system, because user operation functions are preregistered with the S10V.

(chapter 5, page 5-21)

NOTICE

- With the assembler language, the validity of the contents of any register other than the D0 register (return code storage) would be guaranteed. (The C-language need not be register-conscious.)
- Subroutine J_CMD uses 128 bytes of user program stack space.

(chapter 5, page 5-23)

NOTICE

- With the assembler language, the validity of the contents of any register other than the D0 register (return code storage) would be guaranteed. (The C-language need not be register-conscious.)
- Subroutine J_RSP uses 128 bytes of user program stack space.

(chapter 5, page 5-25)

NOTICE

- With the assembler language, the validity of the contents of any register other than the D0 register (return code storage) would be guaranteed. (The C-language need not be register-conscious.)
- Subroutine J_SND uses 128 bytes of user program stack space.
- Because data transmission by subroutine J_SEND takes place in synch with the I/O service, it affects the I/O service refresh cycle.

(chapter 5, page 5-27)

NOTICE

- With the assembler language, the validity of the contents of any register other than the D0 register (return code storage) would be guaranteed. (The C-language need not be register-conscious.)
- Subroutine J_RCV uses 128 bytes of user program stack space.

(chapter 7, page 7-11)

NOTICE

A parameter error occurs when hardware is mounted in a different model from the model in which the parameters shown in “4.2 Commands” were set.

Concretely, there are two cases that are shown below:

Case 1: When the J.NET-INT module in which parameters were set in the S10V is installed in the S10mini, “JNM PRME” or “JNS PRME” is displayed on the CPU indicator.

Case 2: When the J.NET-INT module in which parameters were set in the S10mini is installed in the S10V, 0x0112 is displayed in the error log of the tool (S10V basic system).

The above function is intended to prevent a malfunction by referring to the parameters set in a different model.

When a checksum error occurs in the contents of parameter setting, a parameter error also occurs. When this parameter error occurs, open the parameter setting window in the mounting model and make a setting change as required.

This Page Intentionally Left Blank

WARRANTY AND SERVICING

Unless a special warranty contract has been arranged, the following warranty is applicable to this product.

1. Warranty period and scope

Warranty period

The warranty period for this product is for one year after the product has been delivered to the specified delivery site.

Scope

If a malfunction should occur during the above warranty period while using this product under normal product specification conditions as described in this manual, please deliver the malfunctioning part of the product to the dealer or Hitachi Engineering & Services Co., Ltd. The malfunctioning part will be replaced or repaired free of charge. If the malfunctioning is shipped, however, the shipment charge and packaging expenses must be paid for by the customer.

This warranty is not applicable if any of the following are true.

- The malfunction was caused by handling or use of the product in a manner not specified in the product specifications.
- The malfunction was caused by a unit other than that which was delivered.
- The malfunction was caused by modifications or repairs made by a vendor other than the vendor that delivered the unit.
- The malfunction was caused by a relay or other consumable which has passed the end of its service life.
- The malfunction was caused by a disaster, natural or otherwise, for which the vendor is not responsible.

The warranty mentioned here means the warranty for the individual product that is delivered. Therefore, we cannot be held responsible for any losses or lost profits that result from the operation of this product or from malfunctions of this product. This warranty is valid only in Japan and is not transferable.

2. Range of services

The price of the delivered product does not include on-site servicing fees by engineers. Extra fees will be charged for the following:

- Instruction for installation and adjustments, and witnessing trial operations.
- Inspections, maintenance and adjustments.
- Technical instruction, technical training and training schools.
- Examinations and repairs after the warranty period is concluded.
- Even if the warranty is valid, examination of malfunctions that are caused by reasons outside the above warranty scope.

This Page Intentionally Left Blank

PREFACE

Thank you for purchasing the J.NET-INT module, which is an option for use with the S10mini/S10V.

This manual, named “USER’S MANUAL OPTION J.NET-INT,” describes how to use the J.NET-INT module. For proper use of the J.NET-INT module, it is requested that you thoroughly read this manual.

This S10mini and S10V products are available in two types: standard model and environmentally resistant model. The environmentally resistant model has thicker platings and coatings than those for the standard model.

The model number of the environmentally resistant model is marked by adding the suffix “-Z” to the model number of the standard model.

(Example) Standard model: LQE545

Environmentally resistant model: LQE545-Z

This manual is applicable to both the standard model and environmentally resistant model.

Although the descriptions contained in this manual are based on the standard model, follow the instructions set forth in this manual for proper use of the product even if you use the environmentally resistant model.

If the J.NET-INT module (LQE545) is mounted in an S10V LPU unit, module Rev. B (Ver-Rev: 0002-0001) and earlier modules would not have access to the function of sending and receiving data from C-mode handlers (subroutines); they can only use operation functions. To use C-mode handlers (subroutines) with an S10V LPU unit, module Rev. C (Ver-Rev: 0003-0000) and later modules must be used.

The “Ver-Rev” is the version-revision number of the microprogram of the J.NET-INT module indicated in “Module List” in the S10V BASE SYSTEM.

<Trademarks>

Microsoft® Windows® operating system, Microsoft® Windows® 95 operating system, Microsoft® Windows® 98 operating system, Microsoft® Windows® 2000 operating system, Microsoft® Windows® XP operating system, Microsoft® Windows® 7 (32-bit) operating system are registered trademarks of Microsoft Corporation in the United States and/or other countries.

<Note for storage capacity calculations>

- Memory capacities and requirements, file sizes and storage requirements, etc. must be calculated according to the formula 2^n . The following examples show the results of such calculations by 2^n (to the right of the equals signs).

1 KB (kilobyte) = 1,024 bytes

1 MB (megabyte) = 1,048,576 bytes

1 GB (gigabyte) = 1,073,741,824 bytes

- As for disk capacities, they must be calculated using the formula 10^n . Listed below are the results of calculating the above example capacities using 10^n in place of 2^n .

1 KB (kilobyte) = 1,000 bytes

1 MB (megabyte) = 1,000² bytes

1 GB (gigabyte) = 1,000³ bytes

CONTENTS

1 SPECIFICATIONS	1-1
1.1 Use.....	1-2
1.2 Specifications	1-2
1.2.1 System specifications	1-2
1.2.2 Line specifications.....	1-2
1.3 System Software Specifications.....	1-3
1.3.1 System overview	1-3
1.3.2 Required hardware and software	1-3
2 NAMES AND FUNCTIONS OF EACH PART.....	2-1
2.1 Names and Functions of Each Part	2-2
3 MOUNTING AND WIRING.....	3-1
3.1 Mount Base	3-2
3.2 Mounting the Module.....	3-2
3.3 Ground Wiring	3-4
3.4 Wiring	3-6
3.4.1 Interface signals and wiring method.....	3-6
3.4.2 Cable specifications.....	3-8
3.4.3 Examples of wiring.....	3-9
4 OPERATION	4-1
4.1 Installing and Starting Up the System.....	4-2
4.1.1 Installing.....	4-2
4.1.2 Uninstalling	4-4
4.1.3 Starting up the system	4-5
4.1.4 Changing connections	4-9
4.1.5 Selecting an edition file	4-11
4.1.6 Closing the system.....	4-13
4.2 Commands.....	4-14
4.2.1 Function organization of the J.NET system	4-14
4.2.2 Editing the parameters	4-16
4.2.3 Editing system information	4-18
4.2.4 Editing NET1 information (Editing NET2 information).....	4-19
4.2.5 F/D function.....	4-30
4.2.6 Saving module information	4-31

4.2.7	Transmission.....	4-33
4.2.8	Comparison.....	4-33
4.2.9	Registering user operation functions (S10mini).....	4-34
4.2.10	Refresh cycle monitor.....	4-35
4.2.11	Error information display	4-37
4.2.12	Module error	4-38
4.2.13	Station error	4-39
4.2.14	Printing	4-40
4.2.15	CSV output	4-42
5	PROGRAMMING	5-1
5.1	Software Configuration of the J.NET-INT	5-2
5.2	User-Created Programs	5-5
5.2.1	User programs	5-5
5.2.2	User program reception processing.....	5-5
5.3	NET Status	5-7
5.4	S-register	5-8
5.5	S-table	5-9
5.6	Handlers	5-10
5.6.1	Operation functions	5-10
5.6.2	Subroutines	5-20
5.7	Command/Response Buffer	5-29
5.8	Data Send/Receive Buffer.....	5-31
6	USER GUIDE	6-1
6.1	JEMA Standard Compliance.....	6-2
6.2	Task Start by Interrupt Input.....	6-3
6.2.1	Outline	6-3
6.2.2	Setting and installing the J.STATION.....	6-3
6.2.3	Interrupt task registration	6-4
6.2.4	Starting timing.....	6-5
6.3	Communication Times.....	6-6
7	MAINTENANCE.....	7-1
7.1	Maintenance and Check	7-2
7.2	Troubleshooting	7-3
7.2.1	Procedure	7-3
7.2.2	Trouble detection and solution	7-4

7.2.3	Replacing or adding on the module.....	7-6
7.3	Errors and Countermeasures	7-9
7.3.1	Indicator display messages	7-9
7.3.2	User action.....	7-10
7.3.3	Handler-detected error codes.....	7-14
7.3.4	Communication errors	7-15
7.3.5	Error multiple counter	7-18
7.3.6	Trace.....	7-19
7.4	Memory Map of J.NET-INT Module.....	7-21
7.5	Trouble Report	7-22

FIGURES

Figure 3-1	Mounting the Option Module.....	3-2
Figure 3-2	Ground Wiring	3-4
Figure 3-3	Wiring the Module	3-6
Figure 3-4	Network Wiring Example	3-9
Figure 4-1	[J.NET SYSTEM] Window	4-5
Figure 4-2	The [[S10V] J.NET SYSTEM] Window	4-6
Figure 4-3	The [Communication type] Window.....	4-6
Figure 4-4	The Module Selection Window -- an Example.....	4-7
Figure 4-5	Selecting the [Offline] Radio Button.....	4-7
Figure 4-6	Selecting the Edition File You Want to Edit.....	4-8
Figure 4-7	The [Open] Window -- an Example.....	4-11
Figure 4-8	The [Creation confirmation] Dialog Box	4-12
Figure 4-9	The Error Message Dialog Box Reporting on an Invalid J.NET Setup Info File Specified.....	4-12
Figure 4-10	[Edit] Window (for S10mini).....	4-16
Figure 4-11	[Edit] Window (for S10V)	4-16
Figure 4-12	[F/D] Window (for S10mini)	4-30
Figure 4-13	[F/D] Window (for S10V).....	4-30
Figure 4-14	[Refresh cycle monitor] Window (for S10mini)	4-35
Figure 4-15	[Refresh cycle monitor] Window (for S10V).....	4-36
Figure 4-16	The [Print] Dialog Box.....	4-40
Figure 4-17	The [Save As] Dialog Box	4-42
Figure 5-1	Software Configuration of the J.NET-INT.....	5-2
Figure 7-1	Troubleshooting Flow	7-3
Figure 7-2	Error Freeze Information.....	7-12
Figure 7-3	Address Map of Stack Frames.....	7-13
Figure 7-4	Address Map of Error Multiple Counter	7-18
Figure 7-5	Trace Area Structure	7-19
Figure 7-6	Trace Data Area Structure.....	7-20
Figure 7-7	Memory Map of J.NET-INT Module.....	7-21

TABLES

Table 1-1	Types of System Software (Tools).....	1-3
Table 3-1	Recommended Cable Specifications.....	3-8
Table 5-1	I/O Areas	5-4
Table 5-2	S-table Allocation.....	5-9
Table 5-3	Subroutine Types.....	5-20
Table 7-1	Maintenance and Inspection Items.....	7-2
Table 7-2	S10mini CPU Module Display Messages	7-9
Table 7-3	Error Contents	7-10
Table 7-4	Handler-Detected Error Codes	7-14
Table 7-5	Communication Error Codes.....	7-15
Table 7-6	Station-Detected Error Codes.....	7-16
Table 7-7	Polling Error Codes	7-16
Table 7-8	J.STATION RS-232C Error Codes.....	7-17

This Page Intentionally Left Blank

1 SPECIFICATIONS

1 SPECIFICATIONS

1.1 Use

The J.NET module (Model: LQE545) is connected to a network compliant with the JEMA Level 1 Specifications for Programmable Controller Field Networks to communicate data to and from among a variety of station devices (including J.STATIONs). (It does not support message read/write services, though.) The module can also recognize selected DI input signals as input signals to start tasks.

When this module (LQE545) is used with an S10mini CPU module, it can be intermixed with an J.NET-INT module (LQE045), which is dedicated to the S10mini. (The LQE045 cannot be used with an S10V LPU unit.)

1.2 Specifications

1.2.1 System specifications

Item	Specifications
Model	LQE545
Number of networks	2 networks/module
Maximum number of J.NET-INT module that can be mounted in the mount base	2 modules (*)
Mass	260 g

(*) Total number of the units of the J.NET-INT module (LQE545), J.NET module (LQE540) and IR.LINK module (LQ546) mounted.

1.2.2 Line specifications

Item	Specifications	
Transmission method	Serial (bit serial) transmission	
Electrical interface	RS-485	
Number of stations	Up to 31 stations/1 network (62 stations/module)	
Communication cable	Line type	Two pairs of shielded twisted-pair cables Recommended cable: KPEV-SB 2P 0.5 mm ² (Hitachi Cable, Ltd.)
	Distance	The distance depends on the transmission rate as follows: Transmission rate ≤ 1.0 Mbps: Up to 240 m Transmission rate ≤ 0.5 Mbps: Up to 480 m Transmission rate ≤ 0.25 Mbps: Up to 800 m Transmission rate ≤ 0.125 Mbps: Up to 1,000 m
	Terminal block	11 points (M3 screw), fixed type

1.3 System Software Specifications

1.3.1 System overview

When you use the J.NET-INT module, you must register various items of information in the module. Register the module information using the following system software (tools) and by performing operating procedures similar to those for general Windows® applications.

Table 1-1 Types of System Software (Tools)

Package name	Model		Supply style
	For S10mini	For S10V	
J.NET system	S-7890-27E	S-7895-27E	Optional

1.3.2 Required hardware and software

The following hardware and software are required for the use of the J.NET-INT module system software:

(1) For S10mini

- Personal computer (main unit) containing a Pentium 133 MHz or faster CPU
- Personal computer (main unit) containing a Pentium 300 MHz or faster CPU (when Windows® 2000 or Windows® XP is used)
- Display having a resolution of 800 × 600 dots (SVGA) or higher
- Microsoft® Windows® 95 operating system, Microsoft® Windows® 98 operating system, Microsoft® Windows® 2000 operating system or Microsoft® Windows® XP operating system
- Microsoft® Internet Explorer 4.01 or later
- At least 32 MB of RAM
- At least 64 MB of RAM (when Windows® 2000 is used)
- At least 128 MB of RAM (when Windows® XP is used)
- At least 10 MB of free hard disk space
- Cable for connecting the personal computer to the CPU unit (RS-232C cross cable with D-sub 9-pin connectors) or cable for connecting the personal computer to the ET.NET module (10BASE-T twisted pair cross cable with RJ-45 modular connectors)

1 SPECIFICATIONS

(2) For S10V

- Personal computer (main unit) containing a Pentium 300 MHz or faster CPU, or a 1 GHz or faster CPU (when Windows® 7 (32-bit version) is used)
- Display having a resolution of 800 × 600 dots (SVGA) or higher
- Microsoft® Windows® 2000 operating system, Microsoft® Windows® XP operating system or Microsoft® Windows® 7 (32-bit) operating system
- At least 64 MB of RAM (when Windows® 2000 is used)
- At least 128 MB of RAM (when Windows® XP is used)
- At least 1 GB of RAM (when Windows® 7 (32-bit) is used)
- At least 10 MB of free hard disk space
- Cable for connecting the personal computer to the LPU unit (RS-232C cross cable with D-sub 9-pin connectors) or cable for connecting the personal computer to the CMU or ET.NET module (10BASE-T or 100BASE-TX twisted pair cross cable with RJ-45 modular connectors)

NOTICE

Users of this product must have an adequate knowledge of the Windows® environment and user interface. This system conforms to the Windows® standard. This manual is prepared for users who are familiar with the basic Windows® operating procedures.

2 NAMES AND FUNCTIONS OF EACH PART

2 NAMES AND FUNCTIONS OF EACH PART

2.1 Names and Functions of Each Part

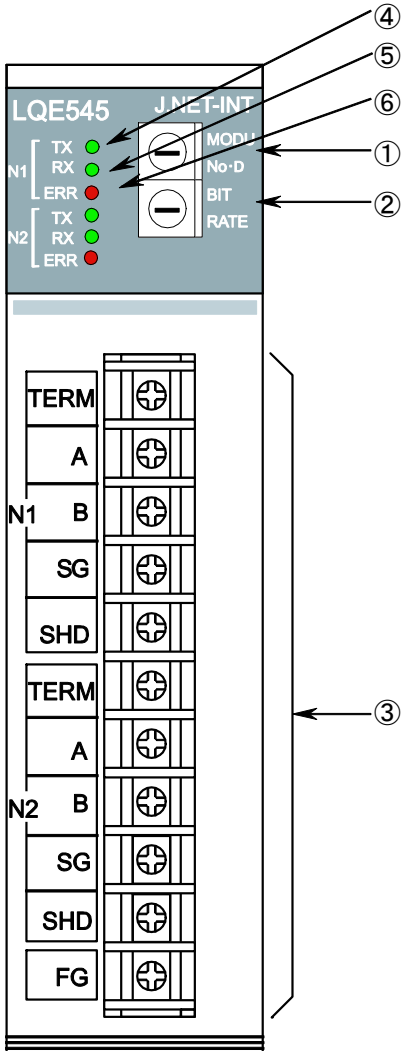

- ① Module number setting switch
Up to two J.NET-INT modules, one main and one sub, can be mounted in one CPU unit. Configure the J.NET-INT modules mounted according to the table below.

Setting No.	Main module/submodule
0	Main module
1	Submodule
2 to F	Setting is disabled

- ② Bit rate setting switch
The bit rate setting switch is used to set a transmission rate. The table below shows the relationship between setting number and transmission rates.

Setting No.	Transmission rate
0	1.0 Mbps
1	0.5 Mbps
2	0.25 Mbps
3	0.125 Mbps

- ③ Terminal blocks for interface
N1, N2: Network numbers
TERM: Terminals for a terminating resistor. Short TERM and A terminal when the J.NET-INT module is used at an end of the network.
A, B: Used to connect a transmission/reception data line.
SG: Used for signal ground terminal.
SHD: Used for shield ground terminal.
FG: Used for frame ground terminal.

- ④ LED for transmission
Comes on when the J.NET-INT module is transmitting data on each network.
- ⑤ LED for reception
Comes on when the J.NET-INT module is receiving data on each network.
- ⑥ LED for errors
Comes on when a hardware error is detected in the J.NET-INT module. When the J.NET-INT module is installed in a different system from the system in which the parameters shown in “4.2 Commands” are set, a parameter error occurs and this LED comes on. (See “7.3.2 User action.”)

NOTICE

Switch off the power supply before operating the module number setting switch and bit rate setting switch.

If you operate while the power supply is applied, it may result in a malfunction.

This Page Intentionally Left Blank

3 MOUNTING AND WIRING

3.1 Mount Base

The J.NET-INT module is mounted in the mount base for use. The table below lists the kinds of mount base in which the J.NET-INT module can be mounted.

Series	Name	Model
S10V	4-slot LPU mount base	HSC-1540
	8-slot LPU mount base	HSC-1580
S10mini	2-slot CPU mount base	HSC-1020
	4-slot CPU mount base	HSC-1040
	8-slot CPU mount base	HSC-1080

3.2 Mounting the Module

Mount the option module in option slots (slot numbers 0 through 7) on the mount base as shown below.

NOTICE

- With the S10mini series, mount the option module at the leftmost positions without an intervening space from the CPU module. Further, leave no open slots between option modules mounted.
- The S10V series places no limitations on the mounting location and available slots.
- If the J.NET-INT module is to be used in conjunction with an LPU module and handlers are to be started with a C-mode program, the J.NET-INT module must be mounted in a pair with a CMU module.

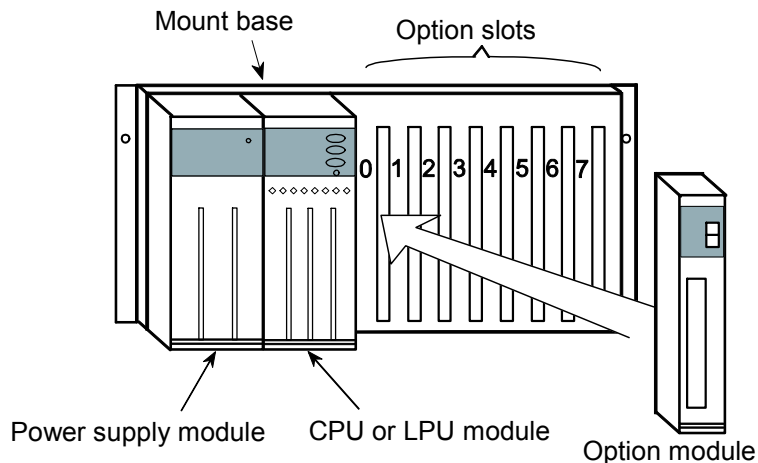

Figure 3-1 Mounting the Option Module

NOTICE

- Dust or other foreign matter might accumulate on the connector, resulting in poor contact. Immediately after the module is unpacked, perform the mounting and wiring procedures.
- To prevent the module from being damaged, observe the following precautions when you mount or demount the module:
 - Before mounting the module to the mount base connector, check that the connector pins are properly aligned and not bent, broken, or soiled with dirt or the like.
 - Ensure that the module is parallel to the mount base vertical surface as shown below when mounting. If you connect a module to or disconnect it from its connector while it is tilted, the connector pins may become damaged.
 - If the mount base is positioned overhead due to the employed enclosure structure, use a stepladder or the like and mount the module squarely. If you mount the module obliquely, the connector may become damaged.

3.3 Ground Wiring

Carry out ground wiring as shown in Figure 3-2 by following these steps:

- ① Connect the FG terminals of the power supply module, CPU module, LPU module, and optional modules by crossover wiring to the mount base's grounding seat, a hexagon nut fitted to the mount base FG terminal (with a wire diameter of 2.0 mm^2 or more).
- ② Wire the mount base FG terminal to the PCs unit grounding point of the enclosure in which the mount base is housed (with a wire diameter of 2.0 mm^2 or more).
- ③ Perform Class D grounding from the PCs unit grounding point of the enclosure using a wire with a wire diameter of 5.5 mm^2 or more.

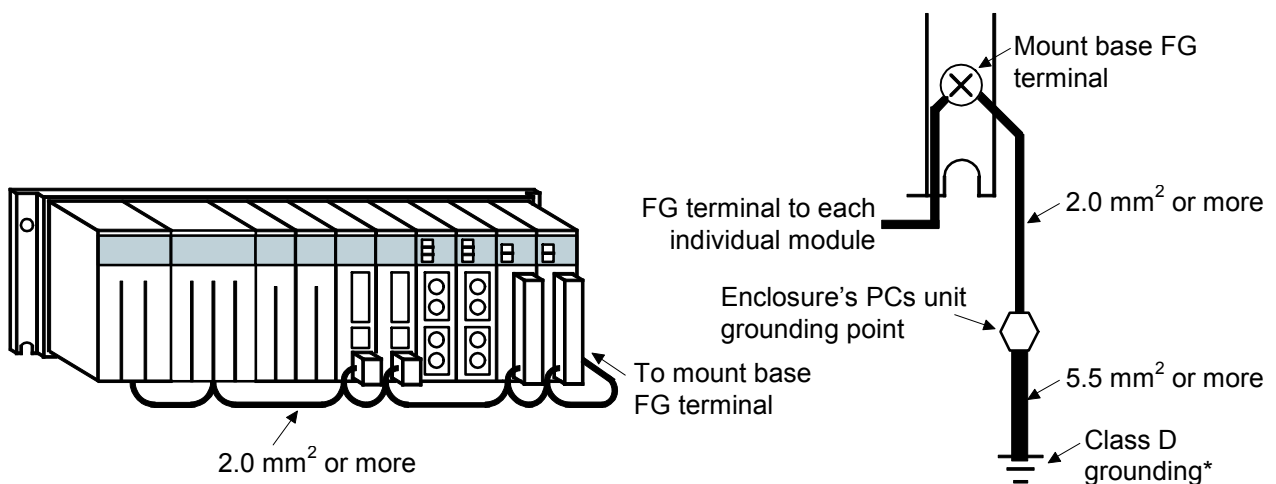

Figure 3-2 Ground Wiring

* Class D grounding is defined in the Technical Standard for Electrical Facilities of Japan. This standard states that the grounding resistance must be 100 ohms or less for equipment operating on 300 VAC or less, and 500 ohms or less for devices that shut down automatically within 0.5 seconds when shorting occurs in low tension lines.

**WARNING**

- Switch off the power supply before making connections to the terminal block. Making connections with the power supply being switched on may incur electrical shock hazards.
- Electric shock hazards exist so that you might suffer burns or become electrocuted. Further, the system might malfunction due to noise interference. Therefore, ground the line ground (LG), frame ground (FG), and shield wire (SHD).

NOTICE

- Insulate the mount base from the enclosure. To keep the mount base insulated, avoid removing the insulation sheets that are supplied with the mount base.
- The LG is a ground terminal for power supply noise. The FG and SHD are ground terminals for the noise in the remote I/O communication module and other external interface lines. To avoid interference between the ground terminals, separately ground the LG and FG.

3.4 Wiring

3.4.1 Interface signals and wiring method

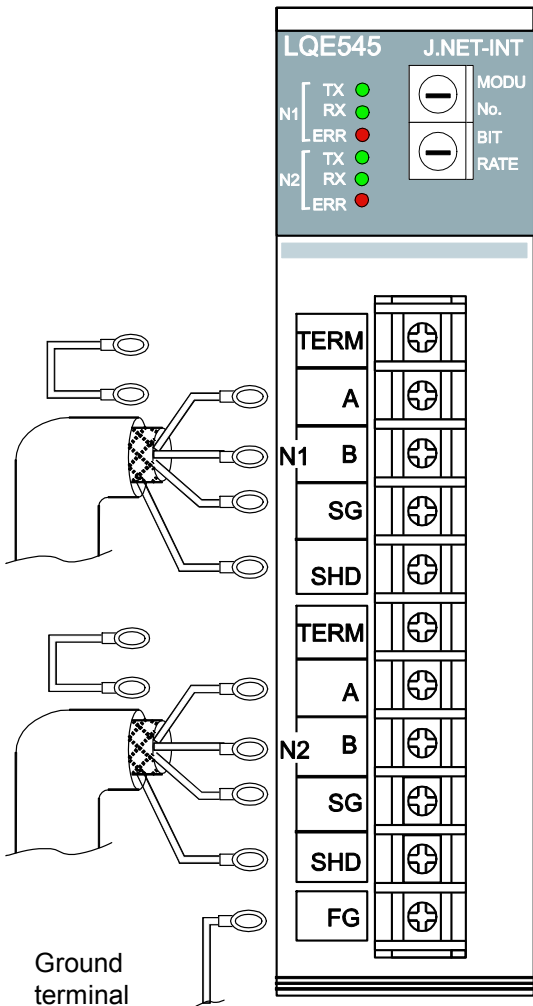

Figure 3-3 Wiring the Module

Network 1 (N1), Network 2 (N2)

Signal name	
Abbreviation	Name
A	Send/receive data (Linkage data)
B	
SG	Grounding for signal (Signal Ground)
SHD	Grounding for shield (SHield ground)
TERM	Terminating resistor for transmission/reception (TERMinal resistor)

Others

Signal name	
Abbreviation	Name
FG	Grounding for frame (Frame Ground)

Interface signal voltage levels

Designation	Mark	Space
Interpretation	1/OFF	0/ON
Output condition	-6 to -1.5 V	1.5 to 6 V
Input condition	-0.2 V or lower	0.2 V or higher

The input condition represents the electric potential of A viewed from B.

Short TERM and A terminal when the J.NET-INT module is used at an end of the network. The terminating resistor (120 ohms) is internally connected.

NOTICE

The two shield ground (SHD) terminals and the frame ground (FG) terminal are wired internally. Be sure to ground the FG terminal.

3 MOUNTING AND WIRING

3.4.2 Cable specifications

The J.NET-INT module requires two pairs of shielded twisted-pair cables.

A polyethylene-insulated vinyl sheath cable for instrumentation should be used as the cable for J.NET-INT and J.STATION.

Table 3-1 Recommended Cable Specifications

Item	Specifications
Maximum conductor resistance (20°C)	34.0 Ω /km
Withstand voltage	1,000 VAC/minute
Minimum insulation resistance (20°C)	2,500 M Ω ·km
Electrostatic capacity (1 kHz)	60 PF/m
Characteristics impedance (1 MHz)	110 Ω

Note: The 1-MHz characteristics impedance of the above cable is 110 ohms but J.NET-INT and J.STATION have 120-ohm internal terminating resistors in consideration of other transmission rates. Short TERM terminals with a jumper when the J.NET-INT module is used at an end of the network. 120-ohm terminating resistors are connected in J.NET-INT and J.STATION.

3.4.3 Examples of wiring

Connect terminating resistors to the devices connected to both ends of the cable. Because the J.NET-INT module supports two independent networks, N1 and N2, they must be wired each as a totally discrete network. An example of typical N1 wiring is shown below. N2 can be wired likewise.

- Wiring in which a J.NET-INT module terminates the N1 line

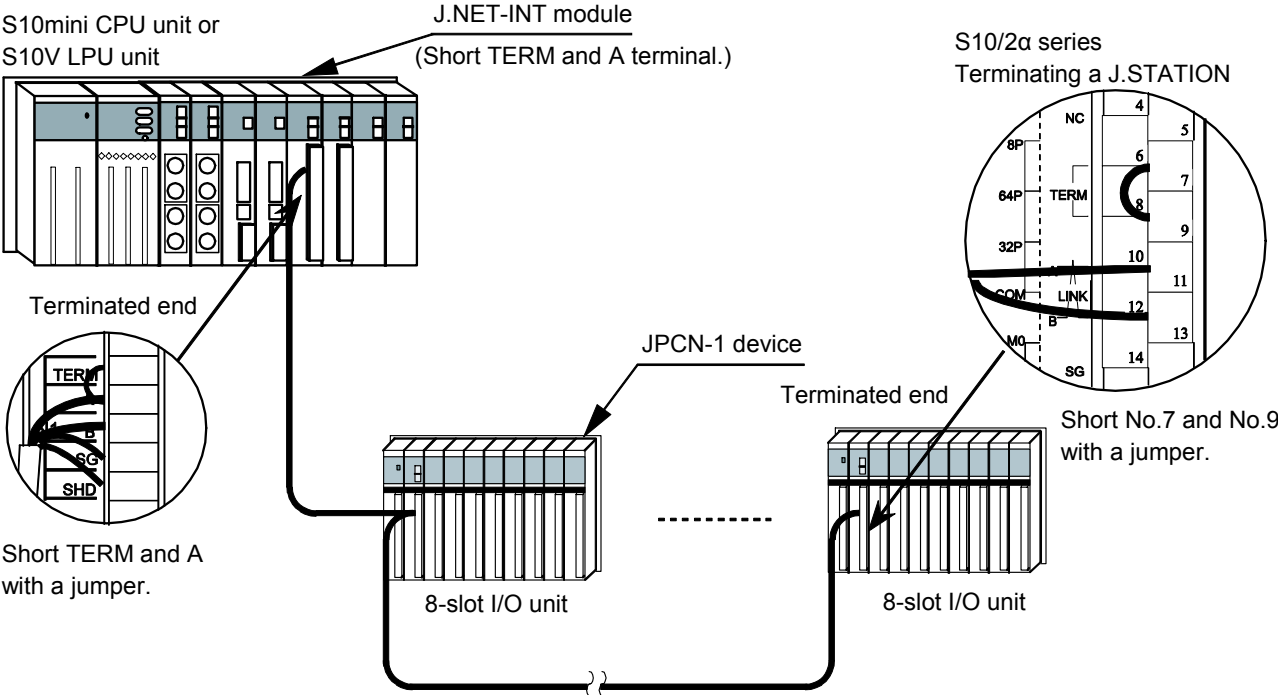

Figure 3-4 Network Wiring Example (1)

3 MOUNTING AND WIRING

- Wiring in which a J.NET-INT module does not terminate the N1 line

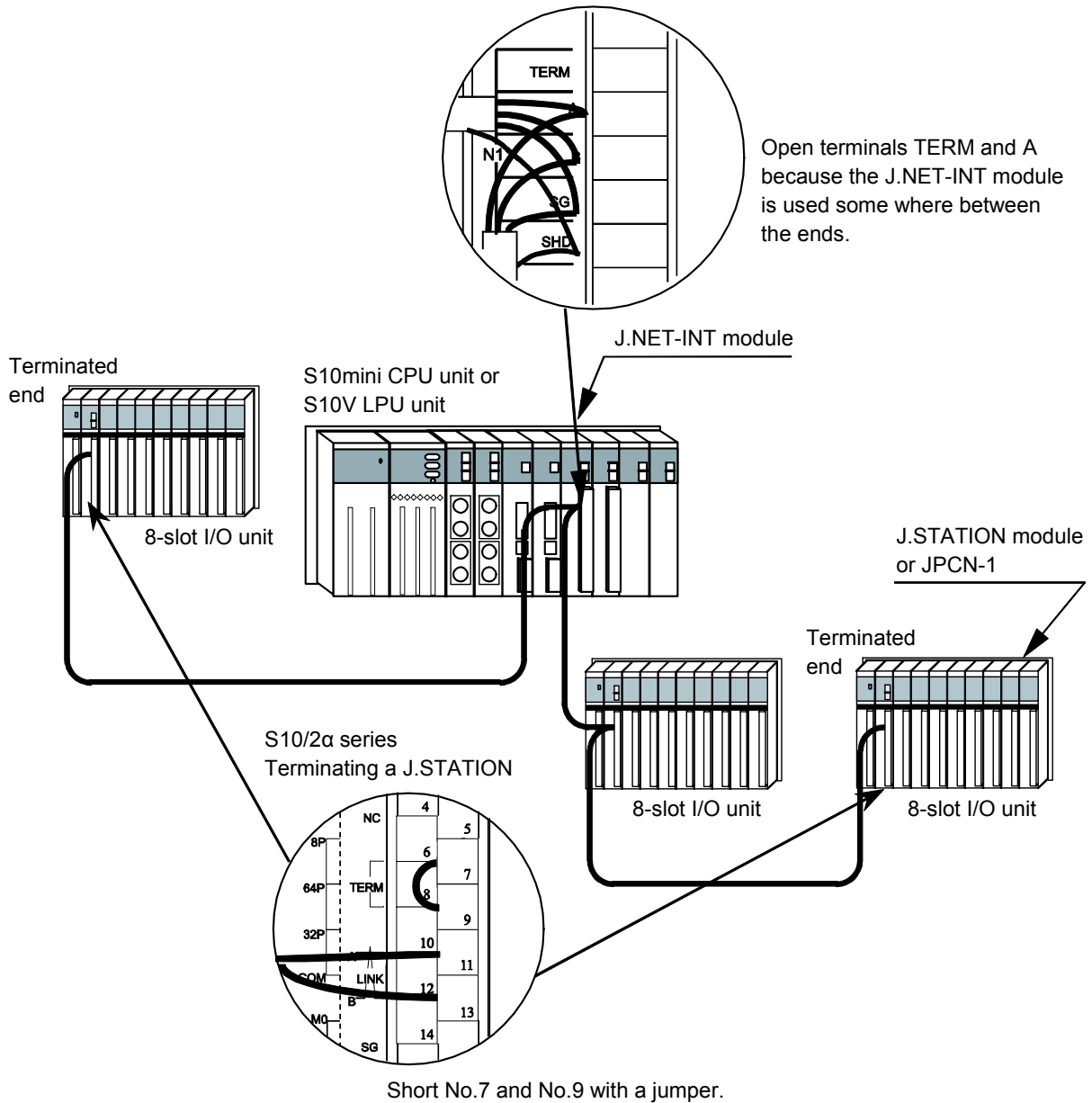

Figure 3-4 Network Wiring Example (2)

4 OPERATION

4.1 Installing and Starting Up the System

4.1.1 Installing

(1) Installing the S10mini J.NET system

To install the S10mini J.NET system, you must execute the setup program by double-clicking the “setup.exe” file stored in the DISK1 folder on the S10mini J.NET system CD. When the J.NET system is installed successfully, create a shortcut on the desktop for that system as necessary, because the window for the installed program is not displayed automatically on the screen. To accomplish this, do the following:

Click the button and choose [(All) Programs] – [Hitachi S10] – [J.NET SYSTEM] – [J.NET SYSTEM] from the [Start] menu on the Windows® screen. Click and hold the right mouse button on the [J.NET SYSTEM] and move the pointer to the desktop. Then, choose [Copy Here] from the pop-up menu.

NOTICE

Before installing the S10mini J.NET system, be sure to exit all the currently open Windows® programs. Do not forget to exit anti-virus software and other memory-resident programs. If you install the S10mini J.NET system without exiting such programs, an error may occur during installation. If such an error occurs, first uninstall the S10mini J.NET system as directed in, “4.1.2 Uninstalling,” exit all the Windows® programs, and then install the S10mini J.NET system again.

(2) Installing the S10V J.NET system

To install the S10V J.NET system, you must execute the setup program that is stored in the S10V IR.LINK system DISK1 folder on the CD.

Double-click “setup.exe” that is stored in the DISK1 folder on the S10V J.NET system CD. Since no window opens upon completion of installation, attach a shortcut to the desktop as needed.

Click the button and choose [(All) Programs] – [Hitachi S10V] – [S10V J.NET SYSTEM] – [S10V J.NET SYSTEM] from the [Start] menu on the Windows® screen. Click and hold the right mouse button on the [S10V J.NET SYSTEM] and move the pointer to the desktop. Then, choose [Copy Here] from the pop-up menu.

<Notes on installing in Windows® 7 (32-bit)>

Installing the S10V J.NET system in Windows® 7 (32-bit) operating system requires prior logging onto the operating system with an appropriate Administrator account, which is the Administrator account first created in the initial condition of your personal computer.

When you have so logged on, you can then double-click “setup.exe” that is stored in the DISK 1 folder on the S10V J.NET System CD. When “setup.exe” is started, the dialog box as shown below will appear. Click the button to continue the execution of the setup program.

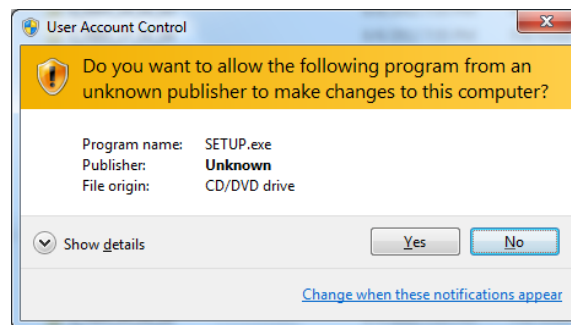

The S10V J.NET system cannot be installed on a per-user basis. To install the J.NET system successfully, the user must first log onto the operating system with an appropriate Administrator account, which is the Administrator account first created in the initial condition of your personal computer.

The S10V J.NET system may not be installed properly in any of the following cases: 1) administrator permission is acquired by using User Account Control(*) with a standard user account and 2) logon is made with an Administrator account that has been created using User Account Control with a standard user account. If you make a logon with a user account that is different from the one you have used for the installation of the S10V J.NET system, the installed program may be missing from the program menu displayed. In this case, you should perform the following series of steps: 1) make a logon again with the Administrator account first created in the initial condition of your personal computer; 2) uninstall the installed program; and 3) install the program again.

When you want to create a new account, be sure to make a logon with an Administrator account. Do not use User Account Control at that time.

(*) User Account Control is a Microsoft Windows feature that temporarily grants administrative rights to standard user accounts.

A message reporting a read-only file detected may be displayed during the reinstallation of the S10V J.NET system. In this case, click the button to set off overwriting.

NOTICE

- The S10V basic system is required for operating the S10V J.NET system. If it is not installed, you cannot install the S10V J.NET system.
- Before installing the S10V J.NET system, be sure to exit all the currently open Windows® programs. Do not forget to exit anti-virus software and other memory-resident programs. If you install the J.NET system without exiting such programs, an error may occur during installation. If such an error occurs, first uninstall the S10V J.NET system as directed in, “4.1.2 Uninstalling,” exit all the Windows® programs, and then install the S10V J.NET system again.

4.1.2 Uninstalling

The existing S10V J.NET system needs to be uninstalled when, for instance, you want to upgrade it. The procedure required for uninstalling it is as follows:

(1) Uninstalling from Windows® 2000

Click on button on your Windows desktop and choose [Settings] - [Control Panel]. When the Control Panel opens, double-click on [Add/Remove Programs]. Then, choose “J.NET SYSTEM” (for S10mini controllers) or “S10V J.NET SYSTEM” (for S10V controllers) in the [Change or Remove Programs] tab and click the [Change/Remove] button. When the [Confirm File Deletion] dialog box appears, click the button.

(2) Uninstalling from Windows® XP

Click on button on your Windows desktop and choose ([Settings] -) [Control Panel]. When the Control Panel opens, double-click on [Add/Remove Programs]. Then, choose “J.NET SYSTEM” (for S10mini controllers) or “S10V J.NET SYSTEM” (for S10V controllers) in the [Change or Remove Programs] tab and click the button. When the [Confirm File Deletion] dialog box appears, click the button.

(3) Uninstalling from Windows® 7 (32-bit) -- for S10V controllers only

Click on button on your Windows desktop and choose [Control Panel]. When the Control Panel opens, click [Programs and features]. Then, select “S10V J.NET SYSTEM” and click button. When the [Confirm File Deletion] dialog box appears, click the button.

NOTICE

- If Windows® opens a window during the uninstall process to display the question “Remove Shared File?,” click the button to retain shared files.
- When you want to reinstall the J.NET system, be sure to perform an uninstall and then perform an install.

4.1.3 Starting up the system

To start up the J.NET system, perform the following procedure:

- S10mini J.NET system startup procedure
- (1) To start up the S10mini J.NET system at the Windows® screen, double-click the “J.NET SYSTEM” icon on the desktop. The S10mini J.NET system can also be started up from the button. To do this, choose [(All) Programs] – [Hitachi S10] – [J.NET SYSTEM] – [J.NET SYSTEM] from the button.
 - (2) The [J.NET SYSTEM] window shown in Figure 4-1 is displayed. Click the button for a desired command.

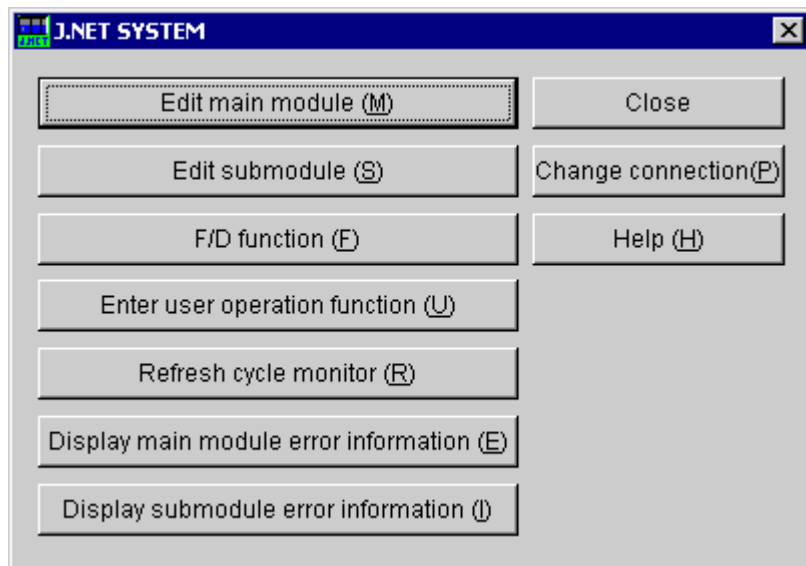

Figure 4-1 [J.NET SYSTEM] Window

4 OPERATION

- S10V J.NET system startup procedure to start it up in online mode

(1) To start up the S10V J.NET system from the Windows® desktop, double-click the “S10V J.NET SYSTEM” icon. The S10V J.NET system can also be started up from the **Start** button. To accomplish this, choose [(All) Programs] – [Hitachi S10V] – [S10V J.NET SYSTEM] – [S10V J.NET SYSTEM] from the **Start** button.

The S10V J.NET system’s main window shown below will then appear. At this stage of the procedure, the J.NET system is not connected with the PCs yet.

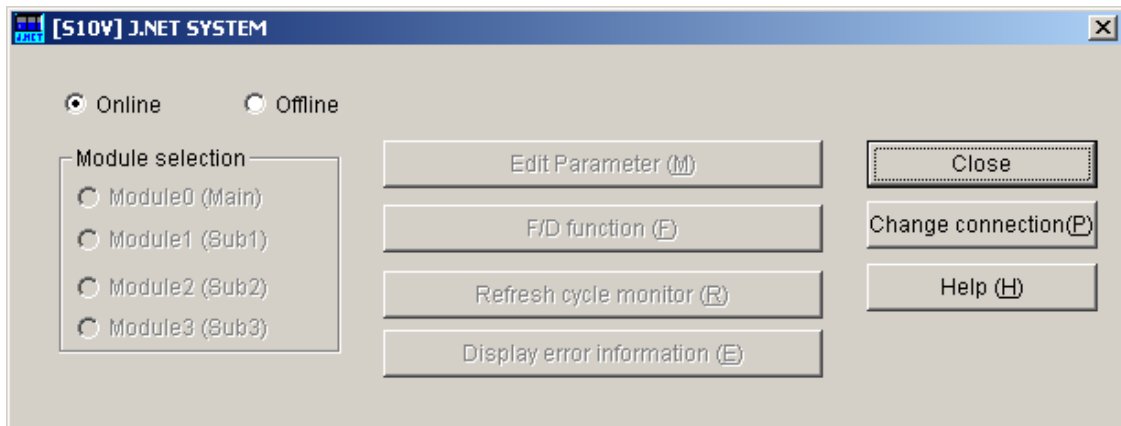

Figure 4-2 The [[S10V] J.NET SYSTEM] Window

(2) By clicking the **Change connection** button in the window, display the [Communication type] window on-screen. When the [Connection type] window appears, specify the desired destination of connection and click the **OK** button (see “4.1.4 Changing connections” for details on the communication type). If you need not change the current connection destination setting, click the **Cancel** button instead.

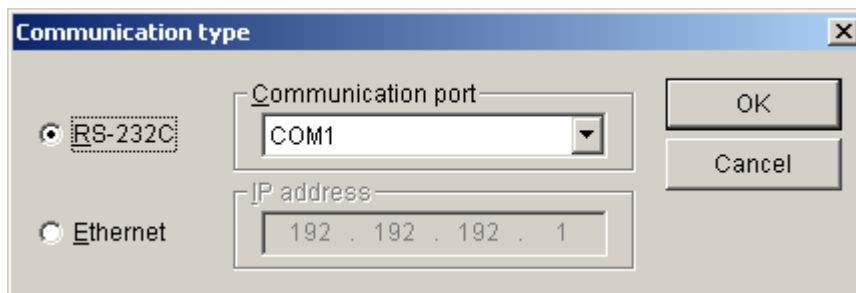

Figure 4-3 The [Communication type] Window

- (3) The module selection window as shown below appears. In this window, the J.NET module's module number (in the range 0 to 3) indicating its mounting position is displayed in gray or black color -- more specifically, if more than one J.NET module is installed in place, the module number (mounting position) of any selected J.NET module is displayed in black color, and the module number (mounting position) of any non-selected J.NET module is displayed in gray color. The module number(s) for which a J.NET module is not installed are grayed out.
- Then, choose the desired command button.

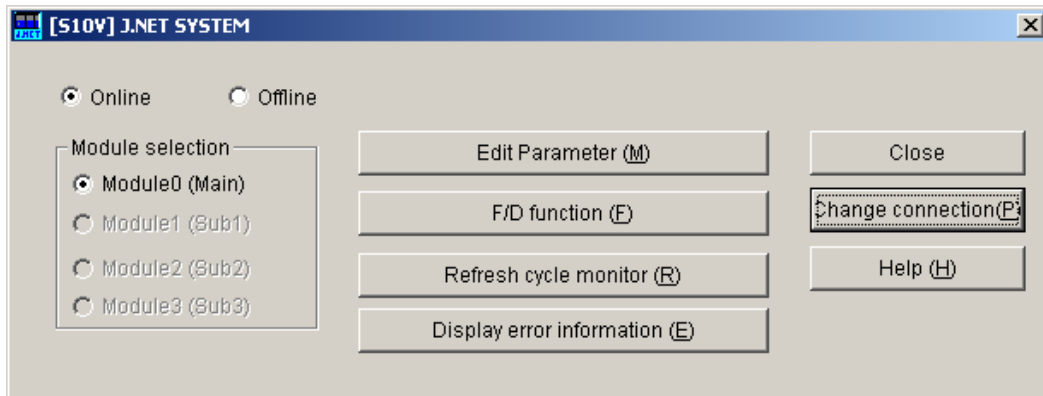

Figure 4-4 The Module Selection Window -- an Example

- S10V J.NET system startup procedure to start it up in offline mode

The procedure described below enables you to create a setup information file for the J.NET and edit it, all in offline mode, even if the actual target machine is not present in your user system. To send the setup information file prepared this way to the target machine, first put the J.NET system into online mode and then send it by using the **F/D function** button (see "4.2.5 F/D function" for details).

- (1) Take the same action as specified in Step (1) under "● S10V J.NET system startup procedure to start it up in online mode."
- (2) Choose the [Offline] radio button. The **Change connection** button is then replaced by the **Edition file select** button.

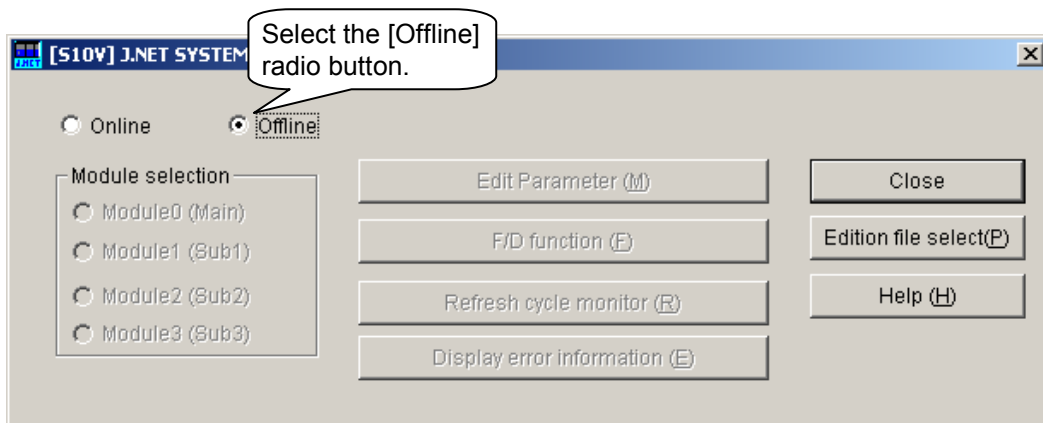

Figure 4-5 Selecting the [Offline] Radio Button

4 OPERATION

- (3) Click the **Edition file select** button and choose the desired J.NET setup information file you want to edit in offline mode.

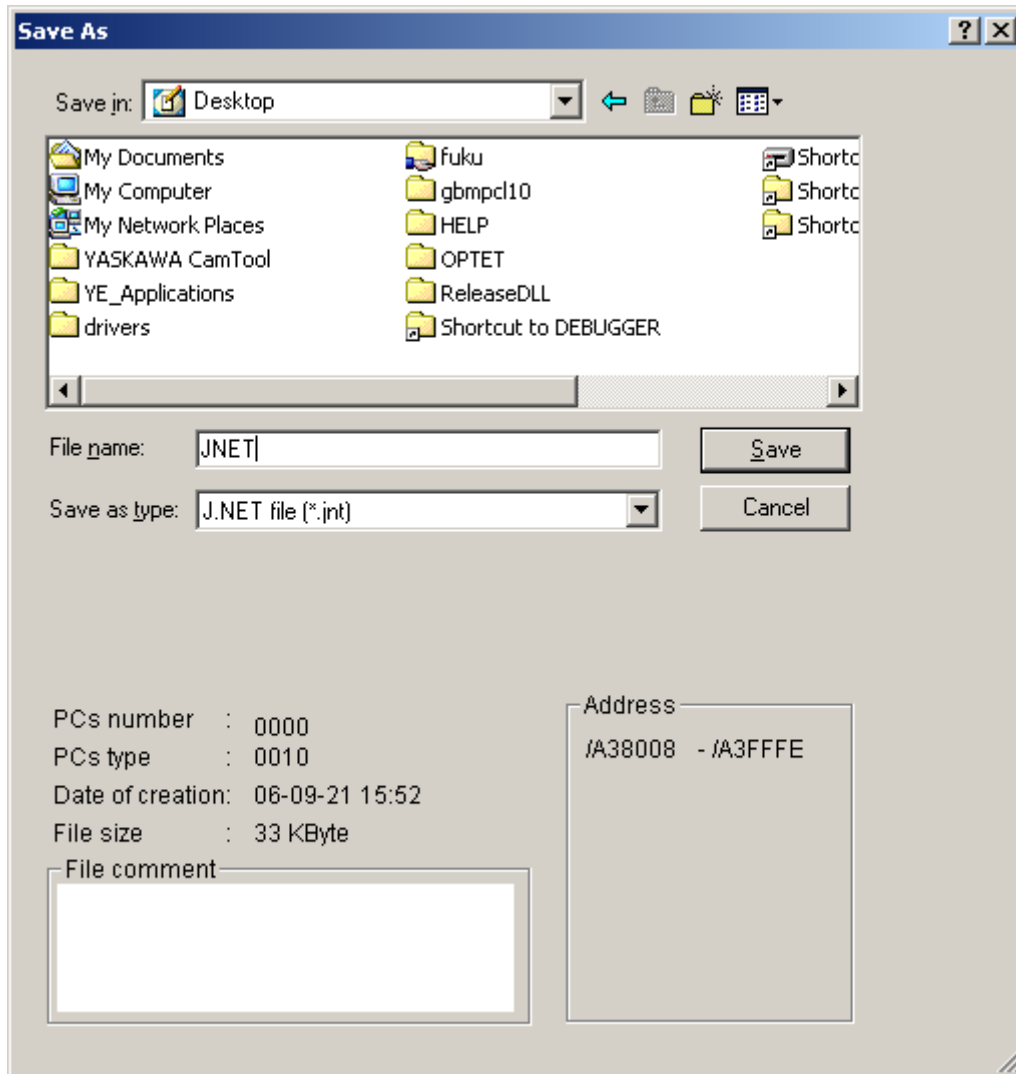

Figure 4-6 Selecting the Edition File You Want to Edit

4.1.4 Changing connections

Function: Sets the PCs-to-personal computer communication type.

Operation: The operating procedure is described below.

- (1) In the [J.NET SYSTEM] window (Figure 4-1) or [[S10V] J.NET SYSTEM] window (Figure 4-2), click the **Change connection** button.
- (2) The [Communication type] window is displayed. (“GPIB” is not displayed for the [S10V] J.NET SYSTEM.)



- (3) For RS-232C communication, click “RS-232C” and then select “Communication port.”

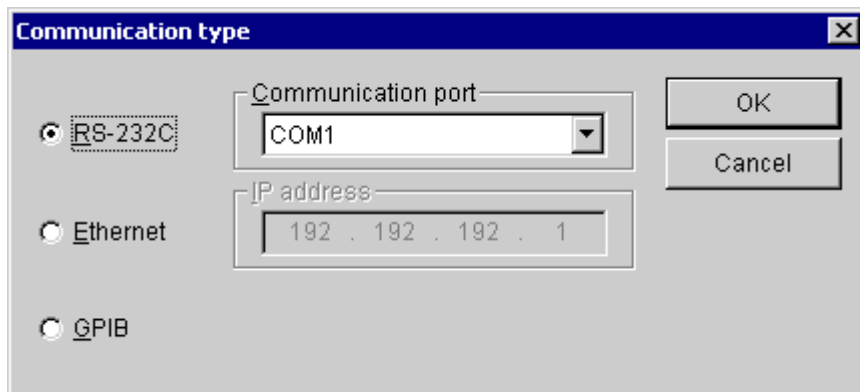

4 OPERATION

- (4) For Ethernet communication, click “Ethernet” and then enter the connection destination “IP address.”

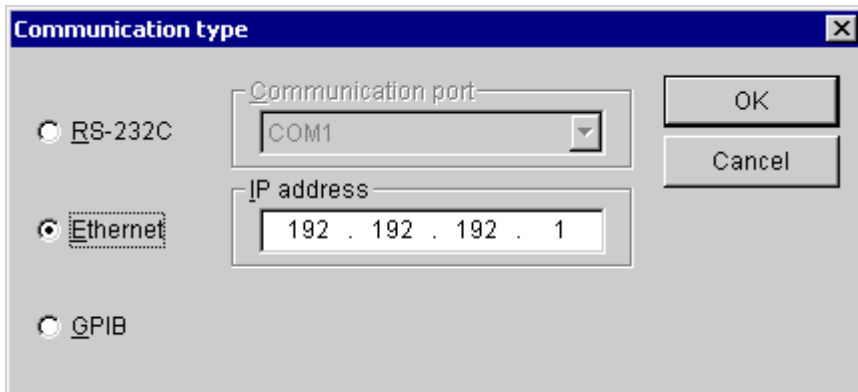

NOTICE

- The S10mini series does not support GP-IB. Do not select “GPIB” on the communication type selection window.
- The S10V series does not support GP-IB. “GPIB” is not displayed on the communication type selection window.

- (5) After completion of setup, click the **OK** button. To abort the setup process, click the **Cancel** button.

4.1.5 Selecting an edition file

Function: The function of this action is to choose an edition file you want to edit in offline mode. The edition files that you can choose for editing are those which have been saved with the F/D function (module info saving) in online mode or have been prepared through offline editing. You can also create a new file by specifying a non-existing file name, provided the type of the controller used is an S10V controller.

Operation: The operating procedure used is described below.

- (1) In the [[S10V] J.NET SYSTEM] window displayed, choose the [Offline] radio button. If it is already selected, skip this step.
- (2) If you have not selected an edition file yet or want to change the currently selected edition file, click the Edition file select button. The [Open] window as shown below will then appear.

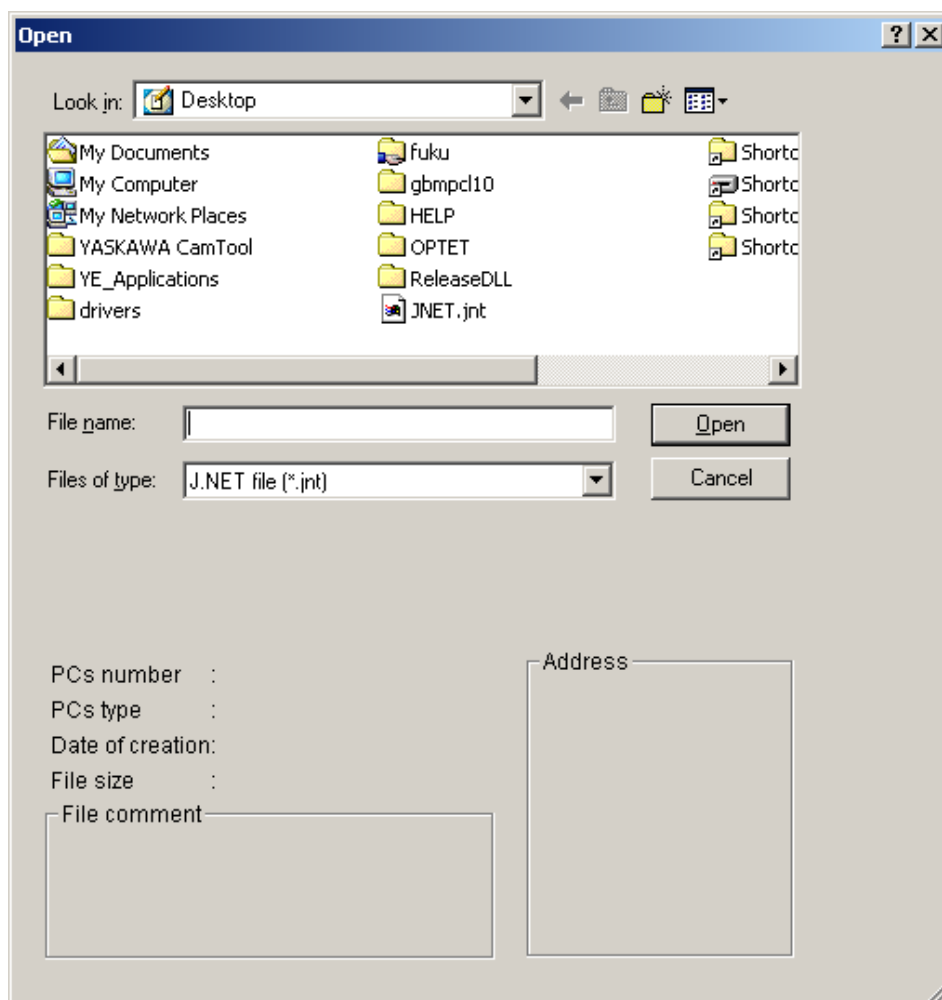

Figure 4-7 The [Open] Window -- an Example

4 OPERATION

- (3) If you want to create a new J.NET setup information file and edit its content, enter a non-existing unique file name and click the **Open** button. The [Creation confirmation] dialog box as shown below will then appear. When it appears, choose the desired module number and click the **OK** button.

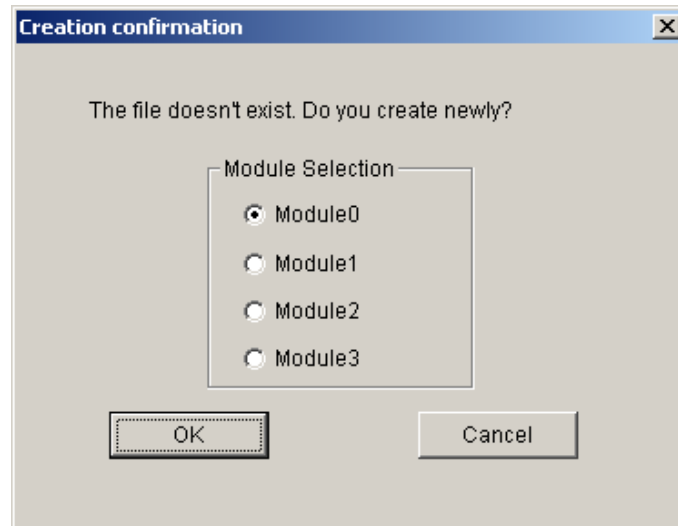

Figure 4-8 The [Creation confirmation] Dialog Box

- (4) If you want to edit an already created J.NET setup information file, choose that file in the [Open] window. Then, when the associated “PCs number” (in decimal), “PCs type” (in hexadecimal), and other information are displayed, click the **Open** button. If the selected file is a non-J.NET setup info file or invalid file, the error message dialog box shown below will appear.

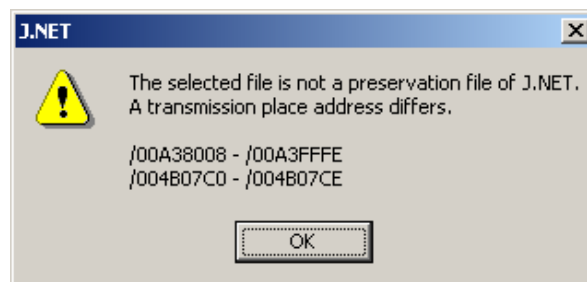

Figure 4-9 The Error Message Dialog Box Reporting on an Invalid J.NET Setup Info File Specified

If the selected file is a valid J.NET setup info file, you can now edit the setup information in that file as you do while the J.NET system is running in online mode.

4.1.6 Closing the system

In the [J.NET SYSTEM] window (Figure 4-1) or [[S10V] J.NET SYSTEM] window (Figure 4-2), click the button or button.

4.2 Commands

4.2.1 Function organization of the J.NET system

(1) Function organization for S10mini controllers

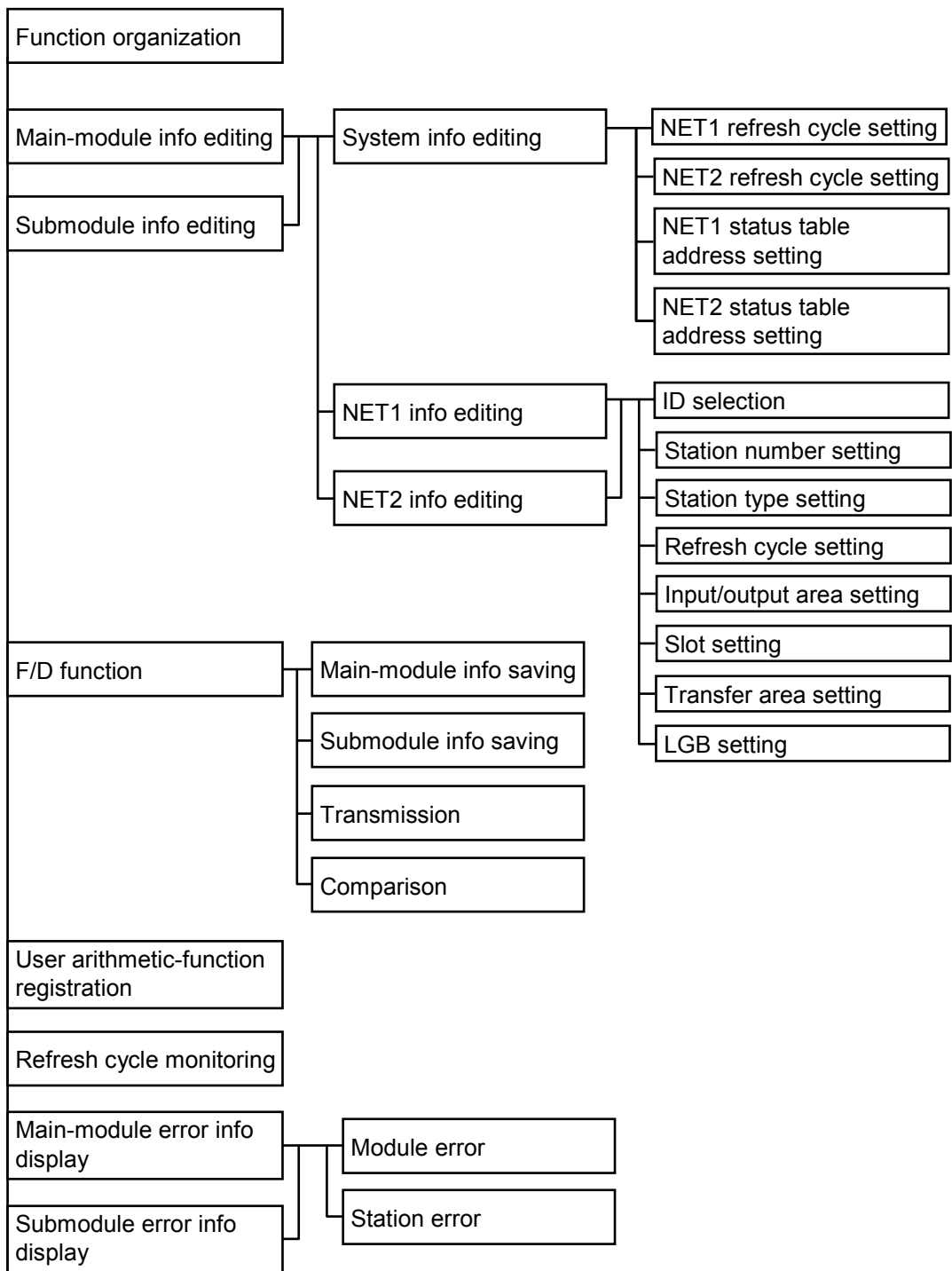

(2) Function organization for S10V controllers

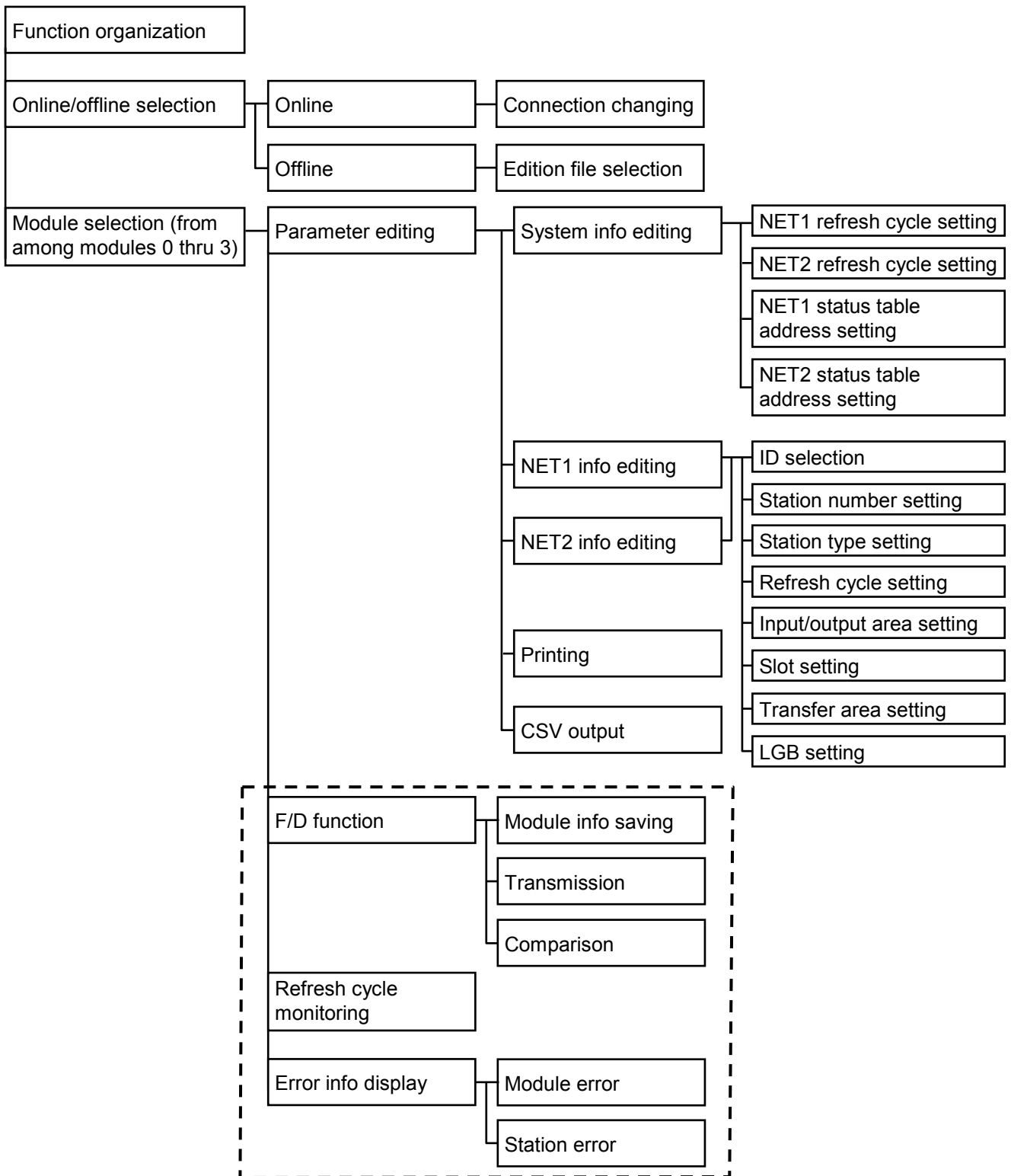

: Indicates that the functions enclosed can be used only when the J.NET system is running in online mode.

4 OPERATION

4.2.2 Editing the parameters

Function: The function of commands used for this purpose is to choose from among editing the module system information, editing NET1 information, and editing NET2 information.

Operation: The operating procedure used is described below. It differs between the S10mini J.NET and the S10V J.NET system.

- Operating procedure for the S10mini J.NET system

- (1) On the [J.NET SYSTEM] window (Figure 4-1), click the or button.
- (2) The [Edit] window (Figure 4-10) is displayed.

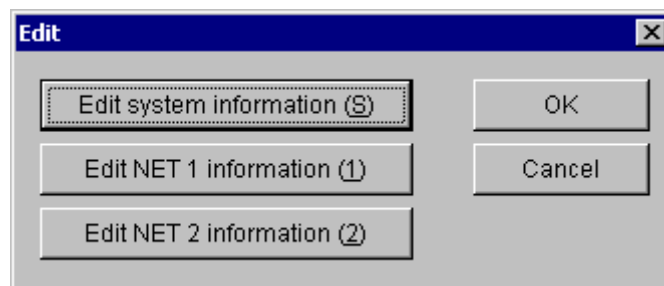

Figure 4-10 [Edit] Window (for S10mini)

- Operating procedure for the S10V J.NET system

- (1) On the [[S10V] J.NET SYSTEM] window (Figure 4-2), choose the desired module in the module selection box and click the button.
- (2) The [Edit] window (Figure 4-11) is displayed.

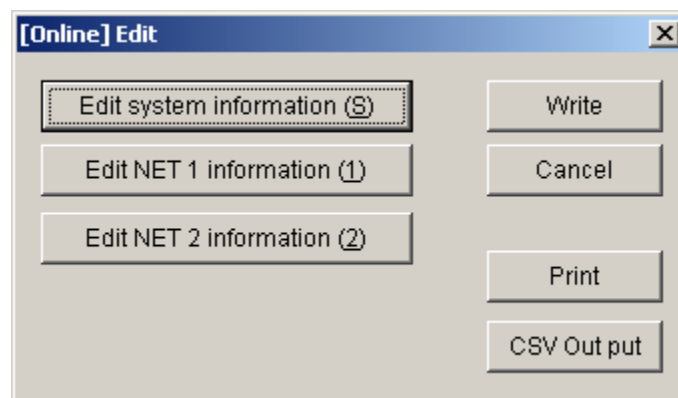

Figure 4-11 [Edit] Window (for S10V)

<Notice>

Each radio button in the module selection box is selectable only when the corresponding module is mounted in place.

Only up to two J.NET-INT modules of models LQE545 or LQE545-Z may be mounted on the single S10V mount base, so Module2 and Module3 (each is a submodule; also called Sub2 and Sub3, respectively) in the module section box are not selectable.

4 OPERATION

4.2.3 Editing system information

Function: The function of commands used for this purpose is to edit the module system information.

Operation: The operating procedure used is described below.

- (1) On the [Edit] window (Figure 4-10 or Figure 4-11), click the Edit system information button.
- (2) The [Edit system information] window is displayed.

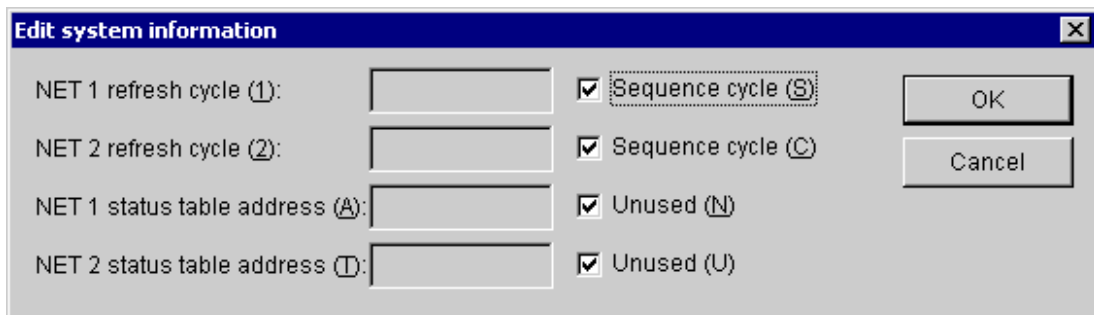

- Setting a NET1 (NET2) refresh cycle

Set a refresh cycle for the I/O service. (If a sequence cycle is selected, the I/O service is refreshed in sync with the sequence cycle.)

Setting range	3 to 3000	Unit [ms]
---------------------------------------------------------------------------	-----------	-----------

- Setting a NET1 (NET2) status table

Set a NET status table.

Address which can be set for S10mini		Address which can be set for S10V	
PI/O setting range	Address setting range	PI/O setting range	Address setting range
X000 to XFFF	/0A0000 to /0A1FFE	X000 to XFFF	/240000 to /241FFE
J000 to JFFF	/0A2000 to /0A3FFE	J000 to JFFF	/0A2000 to /0A3FFE
Y000 to YFFF	/0A4000 to /0A5FFE	Y000 to YFFF	/242000 to /243FFE
Q000 to QFFF	/0A6000 to /0A7FFE	Q000 to QFFF	/0A6000 to /0A7FFE
G000 to GFFF	/0A8000 to /0A9FFE	G000 to GFFF	/0A8000 to /0A9FFE
R000 to RFFF	/0AC000 to /0ADFFE	R000 to RFFF	/0AC000 to /0ADFFE
M000 to MFFF	/0AE000 to /0AFFFE	M000 to MFFF	/0AE000 to /0AFFFE
E400 to EFFF	/0BC800 to /0BDFFE	E400 to EFFF	/0BC800 to /0BDFFE
—	—	LB0000 to LBFFFF	/220000 to /23FFFE

- (3) When the setting is completed, click the OK button. To cancel the setting, click the Cancel button.

4.2.4 Editing NET1 information (Editing NET2 information)

Function: The function of commands used for this purpose is to edit the module NET1 information (NET2 information).

Operation: The operating procedure used is described below.

- (1) On the [Edit] window (Figure 4-10 or Figure 4-11), click the button or button.
- (2) The [Edit information] window is displayed. Click the ID (station ID) to edit, then the button.

Setting range	/01 to /1F
---------------	------------

Edit information										OK
I...	N...	Type	msec	Input b...	Addre...	Output ...	Addre...	Slot	LGB	Cancel
01	**	Unused	*****	**	*****	**	*****	*****	*****	Edit (E)
02	**	Unused	*****	**	*****	**	*****	*****	*****	Delete (D)
03	**	Unused	*****	**	*****	**	*****	*****	*****	
04	**	Unused	*****	**	*****	**	*****	*****	*****	
05	**	Unused	*****	**	*****	**	*****	*****	*****	
06	**	Unused	*****	**	*****	**	*****	*****	*****	
07	**	Unused	*****	**	*****	**	*****	*****	*****	
08	**	Unused	*****	**	*****	**	*****	*****	*****	
09	**	Unused	*****	**	*****	**	*****	*****	*****	
0A	**	Unused	*****	**	*****	**	*****	*****	*****	
0B	**	Unused	*****	**	*****	**	*****	*****	*****	
0C	**	Unused	*****	**	*****	**	*****	*****	*****	
0D	**	Unused	*****	**	*****	**	*****	*****	*****	
0E	**	Unused	*****	**	*****	**	*****	*****	*****	
0F	**	Unused	*****	**	*****	**	*****	*****	*****	
10	**	Unused	*****	**	*****	**	*****	*****	*****	
11	**	Unused	*****	**	*****	**	*****	*****	*****	
12	**	Unused	*****	**	*****	**	*****	*****	*****	
13	**	Unused	*****	**	*****	**	*****	*****	*****	
14	**	Unused	*****	**	*****	**	*****	*****	*****	
15	**	Unused	*****	**	*****	**	*****	*****	*****	
16	**	Unused	*****	**	*****	**	*****	*****	*****	
17	**	Unused	*****	**	*****	**	*****	*****	*****	
18	**	Unused	*****	**	*****	**	*****	*****	*****	
19	**	Unused	*****	**	*****	**	*****	*****	*****	
1A	**	Unused	*****	**	*****	**	*****	*****	*****	
1B	**	Unused	*****	**	*****	**	*****	*****	*****	
1C	**	Unused	*****	**	*****	**	*****	*****	*****	
1D	**	Unused	*****	**	*****	**	*****	*****	*****	
1E	**	Unused	*****	**	*****	**	*****	*****	*****	
1F	**	Unused	*****	**	*****	**	*****	*****	*****	

4 OPERATION

- (3) The [Edit] window is displayed. Set a station number, a station type, and a refresh cycle in this window.

The 'Edit' window contains the following configuration sections:

- Station information:**
 - Station number (N): 00
 - Station type (T): [Dropdown menu]
 - Refresh cycle (C): 0 [*10msec]
- I/O area:**
 - Input byte (W): 000
 - Input address (A): 000000
 - Output byte (O): 000
 - Output address (D): 000000
- Slot:**

Slot num...	I/O type	Transf...	Transfer ...
/0	****	**	*****
/1	****	**	*****
/2	****	**	*****
/3	****	**	*****
/4	****	**	*****
/5	****	**	*****
/6	****	**	*****
- Transfer area:**
 - Transfer byte (R): [Empty field]
 - Transfer address (S): [Empty field]
- LGB:**

Edit item	Set value
Protocol type	Unused
Transfer frame	ST+8DT+OP+1SP
Transmission rate	19200 [bps]
Data conversion m...	BINARY
Idling detection time	1 [*10mSEC]
Start code	No start code
End code	No end code
Block check charac...	No BCC
Transmission dela...	No data transmission delay
Transmission inter...	No transmission interruption/res...
Transmission inter...	No transmission interruption mo...

- Station number

Set the station number to be assigned to the substation.

Setting range	/01 to /7F
---------------	------------

- Station type

Select the station type of the substation. (Choose from among the station types listed below to suit the substation specifications.)

Station type	Specification	Required operation			
		I/O area configuration	Transfer area configuration	Slot information setting	LGB setting
Auto	I/O, unspecified I/O transfer, and polled PUT/GET	√	–	–	–
I/O	I/O and specified I/O transfer	–	–	√	–
I/O+DR/DW	I/O, specified I/O transfer, and polled PUT/GET	–	–	√	–
DR/DW	Polled PUT/GET only	–	–	–	–
J.STATION (EXTENDED)	Hitachi private specification (slot information setting and LGB setting)	–	–	√	√
J.STATION (STANDARD)	Hitachi private specification (transfer word length and transfer address settings only)	–	√	–	–

- Refresh cycle

Set the length of time for which the station monitors the J.NET-INT refresh cycle. This refresh cycle must be at least five times longer than the NET1 (NET2) refresh cycle setting. If any substation registered on the same network fails to communicate successfully after a power failure, disconnection or any other problem, the J.NET-INT refresh cycle might be extended to cause other successfully communicating substations to develop communication errors. To prevent such communication errors, set the values that are calculated by solving the equations below.

Baud rate	Setting (N denotes the number of stations registered)
125 kbps	$\{(N-1) \times 128[\text{ms}] + (\text{NET1}(\text{NET2}) \text{ refresh cycle time}[\text{ms}])\} \times 5$ or more
250 kbps	$\{(N-1) \times 64[\text{ms}] + (\text{NET1}(\text{NET2}) \text{ refresh cycle time}[\text{ms}])\} \times 5$ or more
500 kbps	$\{(N-1) \times 32[\text{ms}] + (\text{NET1}(\text{NET2}) \text{ refresh cycle time}[\text{ms}])\} \times 5$ or more
1 Mbps	$\{(N-1) \times 16[\text{ms}] + (\text{NET1}(\text{NET2}) \text{ refresh cycle time}[\text{ms}])\} \times 5$ or more

Setting range	0 to 65535	(1 Unit = [10ms])
---------------	------------	-------------------

A setting of 0 would suppress refresh cycle monitoring.

4 OPERATION

(4) Slot number setting

Select the number of the I/O slot in which an I/O module mounts.

Setting range	/0 to /F
---------------	----------

Slot setting is enabled if “I/O,” “I/O + DR/DW” or “J.STATION (EXTENDED)” has been selected as a station type.

Click any slot number, then the **Slot Set** button.

When the [Slot Information Setting] window is displayed, fill it out. When the setting is completed, click the **OK** button. To cancel the setting, click the **Cancel** button.

- I/O type

Select the I/O module to mount in the I/O slot.

Choice	Remarks
Delete	Default
DI	
DO	
AI	
AO	
S10 AI (4ch)	
S10 AO (4ch)	
S10 PCT (Pulse counter)	

- Transfer bytes (Byte number)

Setting range	/01 to /100
---------------	-------------

- Transfer address

Address which can be set for S10mini		Address which can be set for S10V	
PI/O setting range	Address setting range	PI/O setting range	Address setting range
XW000 to XWFF0	/0E0000 to /0E01FE	XW000 to XWFF0	/414000 to /4141FE
JW000 to JWFF0	/0E0200 to /0E03FE	JW000 to JWFF0	/0E0200 to /0E03FE
YW000 to YWFF0	/0E0400 to /0E05FE	YW000 to YWFF0	/414200 to /4143FE
QW000 to QWFF0	/0E0600 to /0E07FE	QW000 to QWFF0	/0E0600 to /0E07FE
GW000 to GWFF0	/0E0800 to /0E09FE	GW000 to GWFF0	/0E0800 to /0E09FE
RW000 to RWFF0	/0E0C00 to /0E0DFE	RW000 to RWFF0	/0E0C00 to /0E0DFE
MW000 to MWFF0	/0E0E00 to /0E0FFE	MW000 to MWFF0	/0E0E00 to /0E0FFE
EW400 to EWFF0	/0E1C80 to /0E1DFE	EW400 to EWFF0	/0E1C80 to /0E1DFE
FW000 to FWBFF	/0E2000 to /0E37FE	FW000 to FWBFF	/0E2000 to /0E37FE
– (Extension memory)	/100000 to /4FFFFE (Extension memory)	LBW0000 to LBWFFF0	/412000 to /413FFE
		LWW0000 to LWWFFFF	/450000 to /46FFFFE
		LXW0000 to LXW3FFF	/4A0000 to /4A7FFE

NOTICE

For S10mini, please confirm whether the extension memory corresponding to a set address is mounted when the address of the extension memory is set. The system performance might decrease when the extension memory corresponding to a set address is a unmounting, and mount it, please.

4 OPERATION

(5) LGB setting

LGB setting is enabled if “J.STATION (EXTENDED)” has been selected as a station type.

Click any edit item, then the **Set LGB** button.

Station number (N): 00

Station type (T): J.STATION (EXTENDED)

Refresh cycle (C): 0 [*10msec]

I/O area

Input byte (W): 000

Input address (A): 000000

Output byte (O): 000

Output address (D): 000000

Transfer area

Transfer byte (R):

Transfer address (S):

Slot

Slot num...	I/O type	Transf...	Transfer ...
/0	****	**	*****
/1	****	**	*****
/2	****	**	*****
/3	****	**	*****
/4	****	**	*****
/5	****	**	*****
/6	****	**	*****













LGB

Edit item	Set value
Protocol type	Unused
Transfer frame	ST+8DT+OP+1SP
Transmission rate	19200 [bps]
Data conversion m...	BINARY
Idling detection time	1 [*10mSEC]
Start code	No start code
End code	No end code
Block check charac...	No BCC
Transmission dela...	No data transmission delay
Transmission inter...	No transmission interruption/res...
Transmission inter...	No transmission interruption mo...

- Protocol type

Choice	Display	Remarks
Not used	Not used	Default
Free-running (RS-232C)	Free-running (RS-232C)	

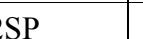
- Transmitted frame

Choice	Display	Transmitted frame	Remarks
ST+7DT+EP+2SP	ST+7DT+EP+2SP	ST 2^0  2^6 EP SP SP	
ST+7DT+OP+2SP	ST+7DT+OP+2SP	ST 2^0  2^6 OP SP SP	
ST+7DT+EP+1SP	ST+7DT+EP+1SP	ST 2^0  2^6 EP SP	
ST+7DT+OP+1SP	ST+7DT+OP+1SP	ST 2^0  2^6 OP SP	
ST+7DT+2SP	ST+7DT+2SP	ST 2^0  2^6 SP SP	
ST+7DT+1SP	ST+7DT+1SP	ST 2^0  2^6 SP	
ST+8DT+EP+2SP	ST+8DT+EP+2SP	ST 2^0  2^7 EP SP SP	
ST+8DT+OP+2SP	ST+8DT+OP+2SP	ST 2^0  2^7 OP SP SP	
ST+8DT+EP+1SP	ST+8DT+EP+1SP	ST 2^0  2^7 EP SP	
ST+8DT+OP+1SP	ST+8DT+OP+1SP	ST 2^0  2^7 OP SP	Default
ST+8DT+2SP	ST+8DT+2SP	ST 2^0  2^7 SP SP	
ST+8DT+1SP	ST+8DT+1SP	ST 2^0  2^7 SP	

The symbols in the table have the following meaning:

ST: Start bit

DT: Data bit

EP: Even parity bit

OP: Odd parity bit

SP: Stop bit

4 OPERATION

- Baud rate

Choice	Display	Remarks
150 [bps]	150 [bps]	
300 [bps]	300 [bps]	
600 [bps]	600 [bps]	
1200 [bps]	1200 [bps]	
2400 [bps]	2400 [bps]	
4800 [bps]	4800 [bps]	
9600 [bps]	9600 [bps]	
19200 [bps]	19200 [bps]	Default

bps: Bits per second

- Data conversion mode

Choice	Display	Remarks
BINARY	BINARY	Transmits text data as binary data (Default).
ASCII	ASCII	Transmits text data as ASCII-coded data.

- Idling detection time

Choice	Display	Idling detection time	Remarks
1 to 32767	1 to 32767[*10mSEC]	10 to 327670[ms]	Default 1 (=10[ms])

- Start code

Choice	Display	Remarks
No start code	No start code	Default
One start code	One start code CD1	
Two start codes	Two start codes CD1+CD2	
Three start codes	Three start codes CD1+CD2+CD3	
Four start codes	Four start codes CD1+CD2+CD3+CD4	

CD1 to CD4: Hexadecimal numbers designating start codes 00H to FFH

- End code

Choice	Display	Remarks
No end code	No end code	Default
One end code	One end code CD1	
Two end codes	Two end codes CD1+CD2	
Three end codes	Three end codes CD1+CD2+CD3	
Four end codes	Four end codes CD1+CD2+CD3+CD4	

CD1 to CD4: Hexadecimal numbers designating end codes 00H to FFH

- Block check character

Choice	Display	Remarks
No BCC	No BCC	Default
Horizontal odd parity check	Horizontal odd parity check	
Horizontal even parity check	Horizontal even parity check	

- Transmission delay

Setting	Display	Remarks
0	No data transmission delay	Default
1 to 32767	1 to 32767 [*10mSEC]	10 to 327670 [ms]

[Limitation]

Verify the transmission delay to ensure that it falls in the following ranges according to the baud rate setting:

Baud rate	Transmission delay setting range
150 [bps]	13 to 32,767 [*10mSEC]
300 [bps]	7 to 32,767 [*10mSEC]
600 [bps]	4 to 32,767 [*10mSEC]
1200 [bps]	2 to 32,767 [*10mSEC]
2400 [bps]	1 to 32,767 [*10mSEC]
4800 [bps]	1 to 32,767 [*10mSEC]
9600 [bps]	1 to 32,767 [*10mSEC]
19200 [bps]	1 to 32,767 [*10mSEC]

4 OPERATION

- Transmission break/resume code

Choice	Display	Remarks
No break/resume code	No break/resume code	Default
One break code and one resume code	BR:CD1 CD:CD2	
One break code and two resume codes	BR:CD1 CD:CD2+CD3	
Two break codes and one resume code	BR:CD1+CD2 CD:CD3	
Two break codes and two resume codes	BR:CD1+CD2 CD:CD3+CD4	

BR: Break code CD: Resume code

CD1 to CD4: Hexadecimal numbers designating transmission break and resume codes
00H to FFH

- Transmission break monitoring time

Setting	Display	Remarks
0	No text transmission delay	Default
1 to 32767	1 to 32767 [*10mSEC]	10 to 327670 [ms]

- Output signal control

Choice	Display	Remarks
No control	No control	Default
RS and ER controls available	RS and ER controls available	

- Input signal check

Choice	Display	Remarks
No check	No check	Default
CS, DR and CD checks available	CS, DR and CD checks available	

- Receiving task number

Setting	Display	Remarks
0	No receiving task registered	Default
1 to 127	1 to 127	S10mini task number
1 to 255 (Note)	1 to 255	S10V task number

(Note) Tasks 230 to 255 are used by the system and won't start.

- Receiving task start factor

Setting	Display	Remarks
0	Not used	Default
1 to 16	1 to 16	S10mini start factor
1 to 32	1 to 32	S10V start factor

- (6) When the setting is completed, click the button. To cancel the setting, click the button.

4 OPERATION

4.2.5 F/D function

Function: The function of this command is to save system information for the modules, transmit it to the PCs, and compare it with the PCs.

Operation: The operating procedure used is described below. It differs between the S10mini J.NET and the S10V J.NET system.

- Operating procedure for the S10mini J.NET system

- (1) On the [J.NET SYSTEM] window (Figure 4-1), click the **F/D function** button.
- (2) The [F/D] window (Figure 4-12) is displayed.

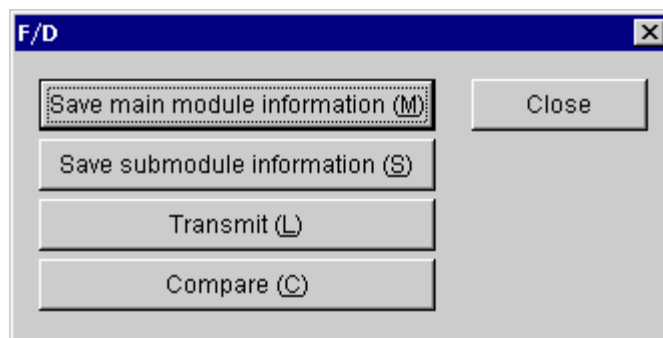

Figure 4-12 [F/D] Window (for S10mini)

- Operating procedure for the S10V J.NET system

- (1) On the [[S10V] J.NET SYSTEM] window (Figure 4-2), choose the desired module in the module selection box and click the **F/D function** button. (As long as you use a command other than the “Save module information”, it does not matter which module is selected.)
- (2) The [F/D] window (Figure 4-13) is displayed.

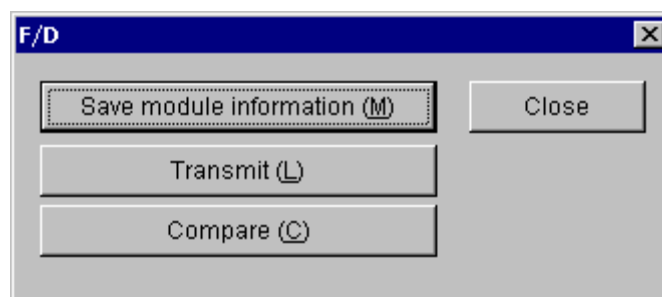

Figure 4-13 [F/D] Window (for S10V)

4.2.6 Saving module information

Function: The function of commands used for this purpose is to save system information for the module.

Operation: The operating procedure used is described below. It differs between the S10mini J.NET and the S10V J.NET system.

- Operating procedure for the S10mini J.NET system

- (1) On the [F/D] window (Figure 4-12), click the **Save main module information** button or **Save submodule information** button.
- (2) The [Save As] window is displayed.

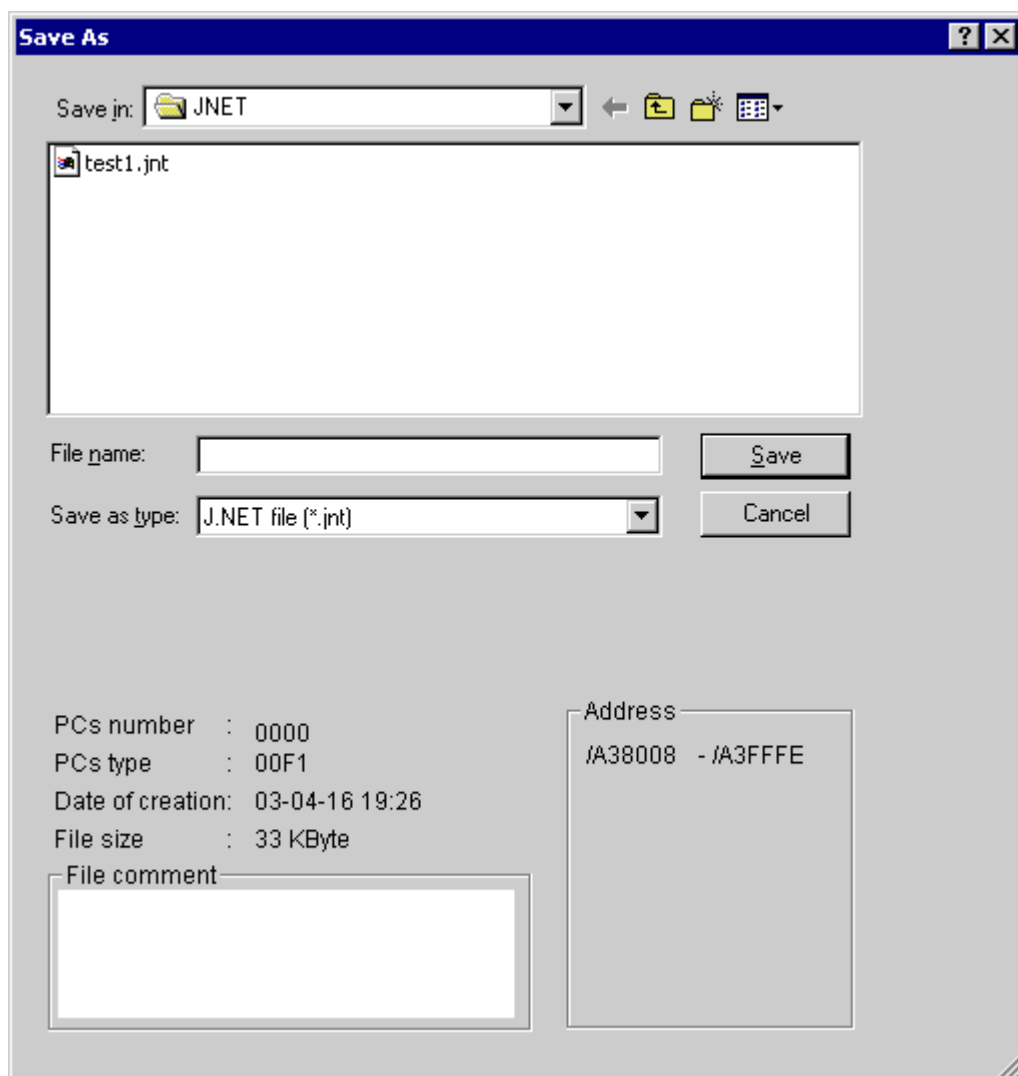

- (3) After completing the setting, click the **Save** button. To cancel the information, click the **Cancel** button on the [Save As] window.

4 OPERATION

- Operating procedure for the S10V J.NET system

- (1) On the [F/D] window (Figure 4-13), click the **Save module information** button. The module for which module information will be saved is one that was selected in the module selection box on the [[S10V] J.NET SYSTEM] window.
- (2) The [Save As] window is displayed. Enter the desired file name.

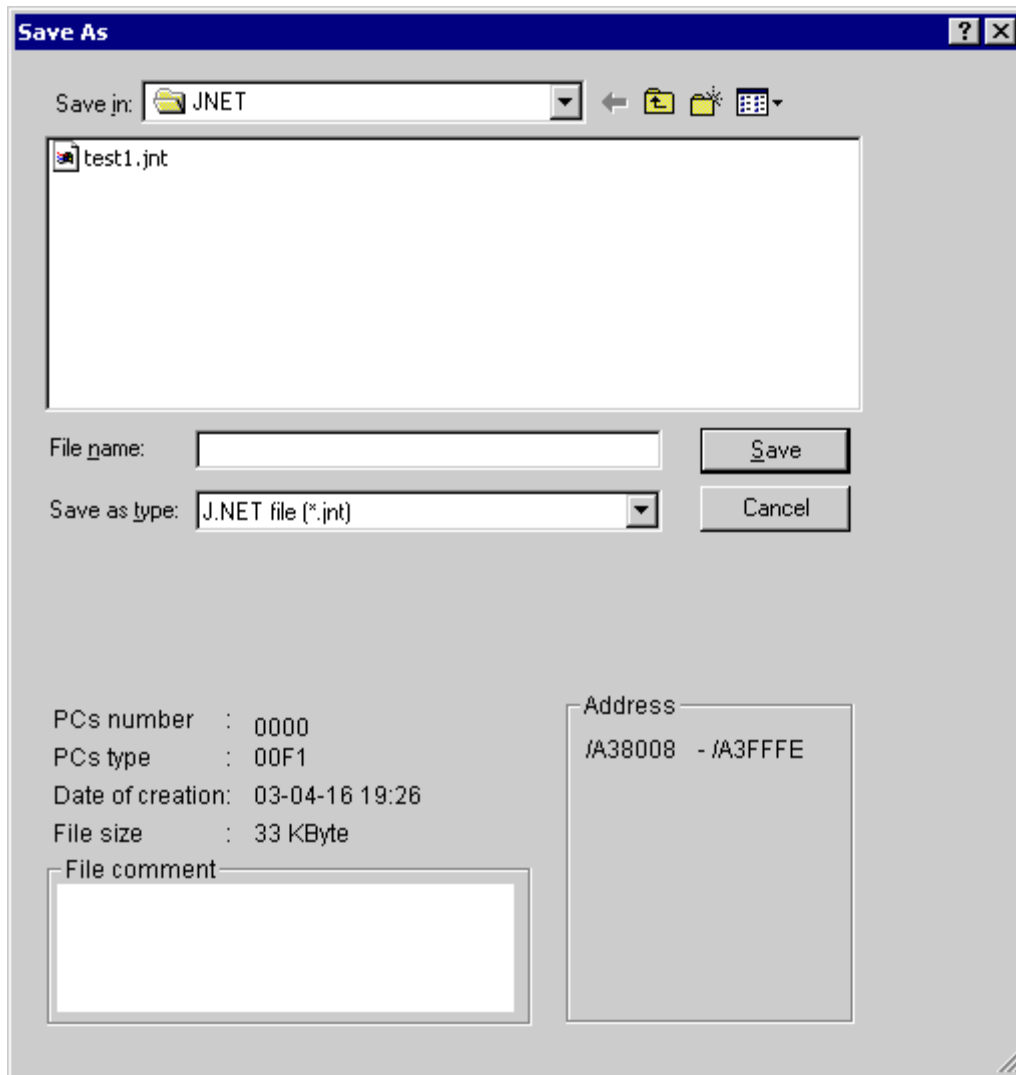

- (3) When the file name is entered, click the **Save** button. If you do not want to save it, click the **Cancel** button instead.

4.2.7 Transmission

Function: The function of commands used for this purpose is to transmit J.NET system information to the PCs.

Operation: The operating procedure used is described below.

- (1) On the [F/D] window (Figure 4-12 or Figure 4-13), click the **Transmit** button.
- (2) The [Open] window is displayed. Enter the file name.

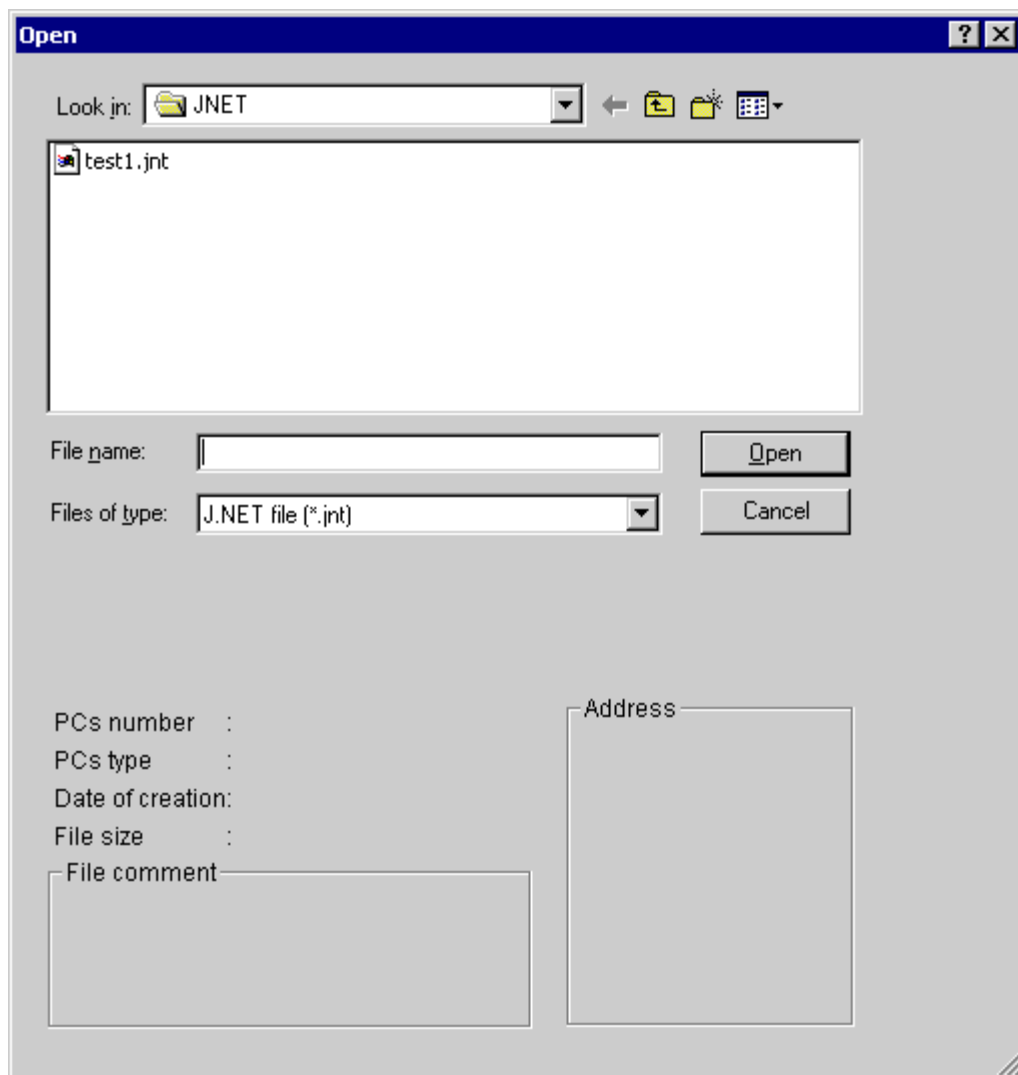

- (3) After completing the setting, Click the **Open** button.
To cancel the transmission, click the **Cancel** button on the [Open] window.

4.2.8 Comparison

Function: The function of commands used for this purpose is to compare J.NET system information with the PCs.

Operation: The operating procedure used is described below.
See “4.2.7 Transmission.”

4 OPERATION

4.2.9 Registering user operation functions (S10mini)

Function: The function of commands used for this purpose is to register user operation functions.

(This function is not available on the [S10V] J.NET system because user operation functions are preregistered with the S10V.)

Operation: The operating procedure used is described below.

- (1) On the [J.NET SYSTEM] window, click the **Enter user operation function** button.
- (2) The [Operation function table] window is displayed. Click the number of the user operation function to register, then the **Set** button.

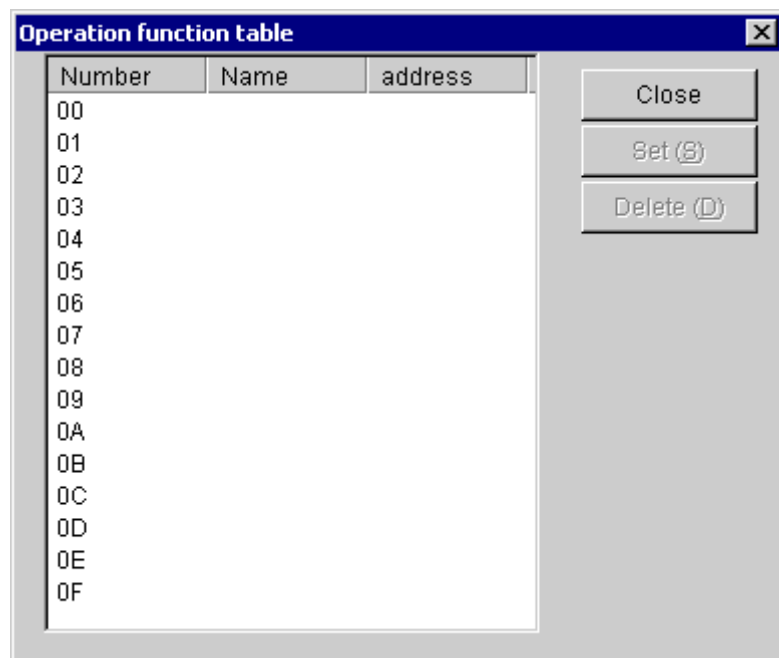

- (3) The [Set] window is displayed. Enter the name.

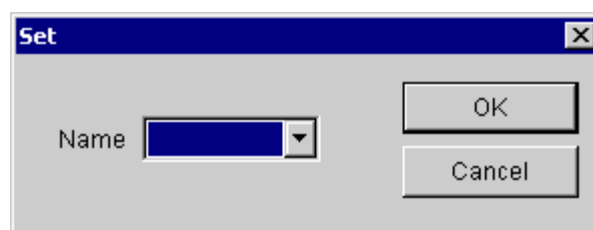

- (4) After completing the setting, click the **OK** button. To cancel the setting, click the **Cancel** button.

4.2.10 Refresh cycle monitor

Function: The function of this command is to monitor the refresh cycle.

Operation: The operating procedure used is described below.

- (1) On the [J.NET] window or [[S10V] J.NET] window, click the Refresh cycle monitor button.
- (2) The [Refresh cycle monitor] window is displayed. The [Refresh cycle monitor] window is not displayed on the [S10V] J.NET system because the S10V supports the sequence cycle and CPU load factor items with the S10V basic system.

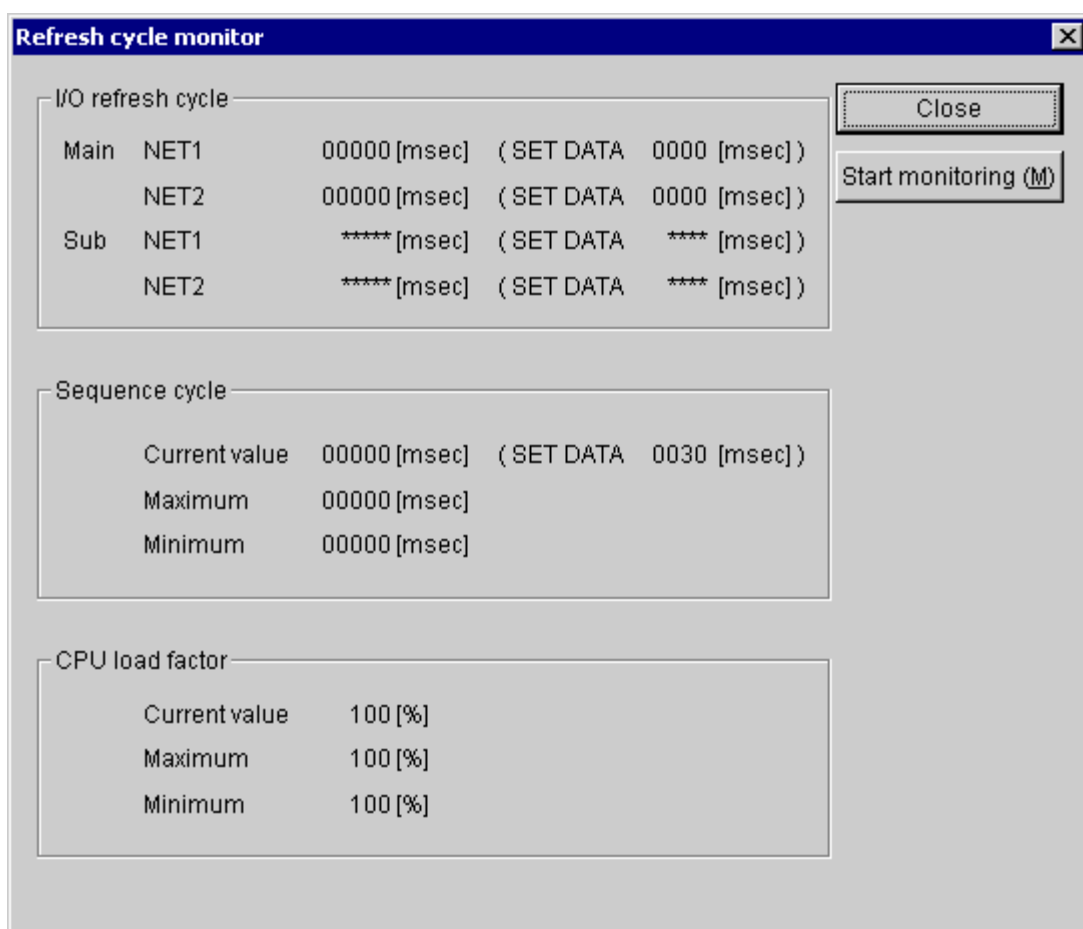

Figure 4-14 [Refresh cycle monitor] Window (for S10mini)

4 OPERATION

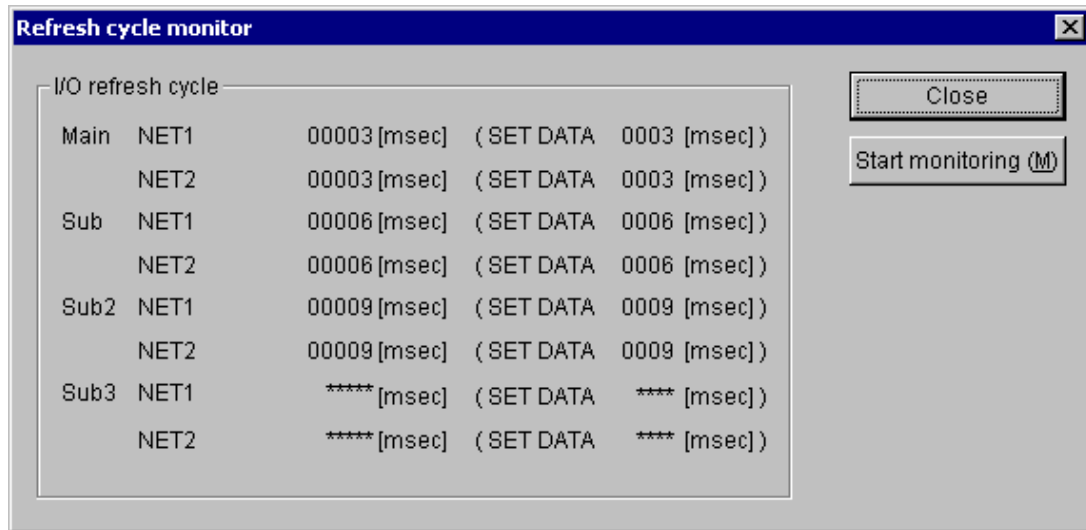

Figure 4-15 [Refresh cycle monitor] Window (for S10V)

- (3) To start monitoring, click the **Start monitoring** button. To stop monitoring in the monitoring status, click the **Stop monitoring** button.
To exit monitoring, click the **Close** button.

4.2.11 Error information display

Function: The function of commands used for this purpose is to enable you to select between module error and station error for displaying error information for the module.

Operation: The operating procedure used is described below. It differs between the S10mini J.NET and the S10V J.NET system.

- Operating procedure for the S10mini J.NET system

(1) On the [J.NET SYSTEM] window (Figure 4-1), click the

button or button.

(2) The [Error information] window below is displayed.

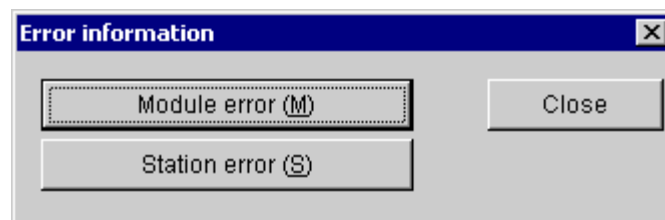

- Operating procedure for the S10V J.NET system

(1) On the [[S10V] J.NET SYSTEM] window (Figure 4-2), choose the desired module in the module selection box for which to display the error information, and click the

button.

(2) The [Error information] window below is displayed.

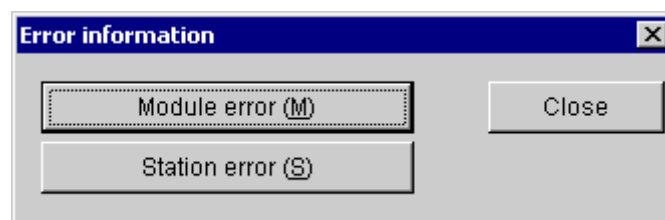

4 OPERATION

4.2.12 Module error

Function: The function of this command is to display error information for the module.

Operation: The operating procedure used is described below.

- (1) On the [Error information] window, click the button. When the module is normal, the message dialog “The module is normal” appears.
If the module is not normal, the [Module error] window is displayed.

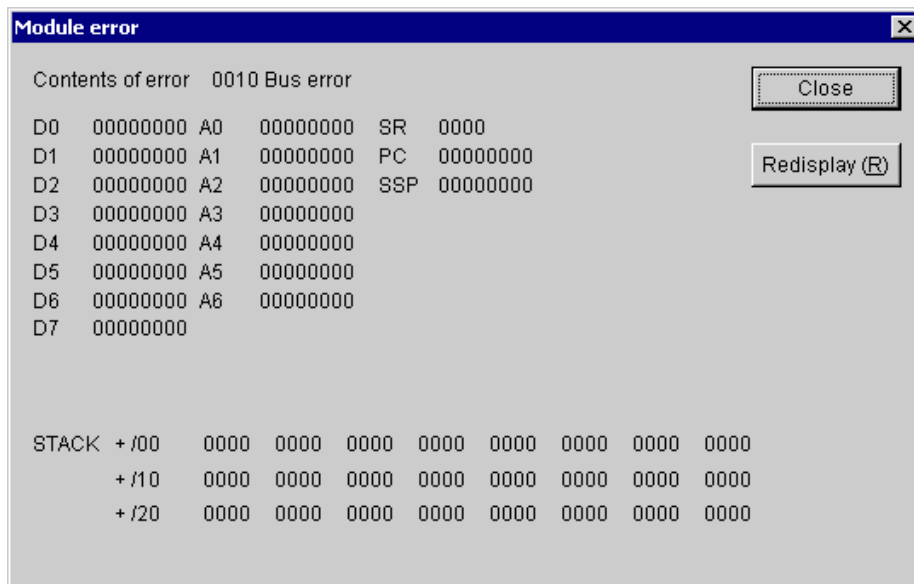

- (2) Clicking the button displays the latest error information.
To exit from the [Module error] window, click the button.

4.2.13 Station error

Function: The function of this command is to display station error information for the module.

Operation: The operating procedure used is described below.

- (1) On the [Error information] window, click the **Station error** button. The station error information of the module is displayed.

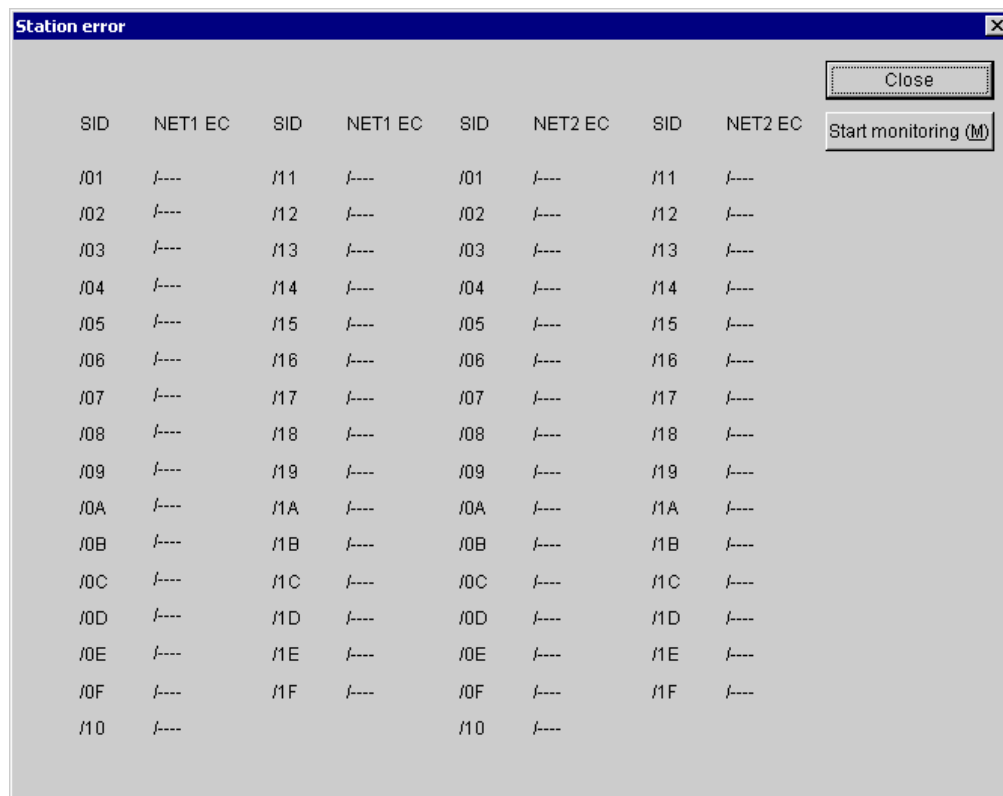

- (2) To start monitoring, click the **Start monitoring** button. To stop monitoring in the monitoring status, click the **Stop monitoring** button.
To exit the [Station error] window, click the **Close** button.

4 OPERATION

4.2.14 Printing

Function: The function of commands used for this purpose is to print on the printer one of the following two pieces of information: 1) the setup information for a selected module from the actual target machine if the J.NET system is running in online mode; or 2) the content (setup information) of a selected file if it is running in offline mode. This function is supported only in S10V controller systems.

Operation: The operating procedure used is described below.

- (1) If the J.NET system is running in online mode, establish a connection between the J.NET system and the PCs (see “4.1.4 Changing connections”). If it is running in offline mode, choose the desired edition file (see “4.1.5 Selecting an edition file”).
- (2) Click the **Edit Parameter** button in the [[S10V] J.NET SYSTEM] window (Figure 4-2). The [Edit] window will then appear.
- (3) In the [Edit] window displayed, click the **Print** button.
- (4) The [Print] dialog box appears. In this dialog box, specify the desired printer and its properties, and then click the **OK** button.

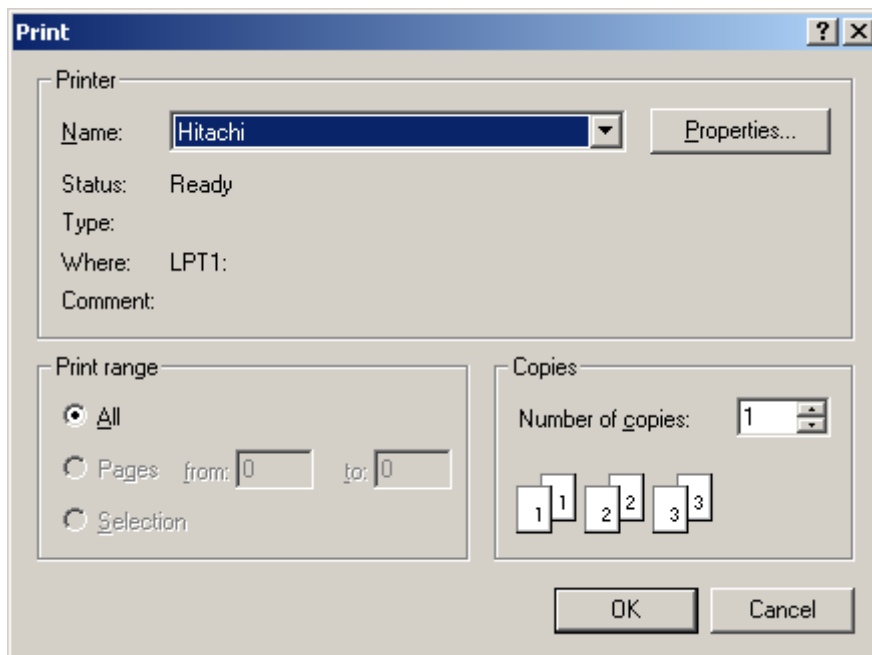

Figure 4-16 The [Print] Dialog Box

<Sample printout>

J.NET 2006/09/21 16:04:47
 Ethrer Net(158.212.99.1)

**** NET1 INFO ****

System Info
 Refresh Cycle 30[ms]
 Status TBL Address Unused

Station Info									
ID	Station No	Station Type	Refresh Cyc	In Byte	In Addr	Out Byte	Out Addr	Slot	LGB
01	01	AUTO	000100	20	FW100	20	FW200	VALID	*****

ID 01 Slot Info			
Slot number	I/O type	Transfer byte count	Transfer address
/0	DI	20	FW100
/1	DO	20	FW200
/2	****	**	*****
/3	****	**	*****
/4	****	**	*****
/5	****	**	*****
/6	****	**	*****
/7	****	**	*****
/8	****	**	*****
/9	****	**	*****
/A	****	**	*****
/B	****	**	*****
/C	****	**	*****
/D	****	**	*****
/E	****	**	*****
/F	****	**	*****

**** NET2 INFO ****

System Info
 Refresh Cycle 40[ms]
 Status TBL Address Unused

Station Info									
ID	Station No	Station Type	Refresh Cyc	In Byte	In Addr	Out Byte	Out Addr	Slot	LGB

4 OPERATION

4.2.15 CSV output

Function: The function of commands used for this purpose is to output to a file in CSV format one of the following two pieces of information: 1) the setup information for a selected module from the actual target machine if the J.NET system is running in online mode; or 2) the content (setup information) of a selected file if it is running in offline mode.

This function is supported only in S10V controller systems.

Operation: The operating procedure used is described below.

- (1) If the J.NET system is running in online mode, establish a connection between the J.NET system and the PCs (see “4.1.4 Changing connections”). If it is running in offline mode, choose the desired edition file (see “4.1.5 Selecting an edition file”).
- (2) Click the **Edit Parameter** button in the [[S10V] J.NET SYSTEM] window (Figure 4-2). The [Edit] window will then appear.
- (3) In the [Edit] window displayed, click the **CSV output** button.
- (4) The [Save As] dialog box appears. In this dialog box, specify the desired folder and file to which you want to output the setup information, and then click the **Save** button.

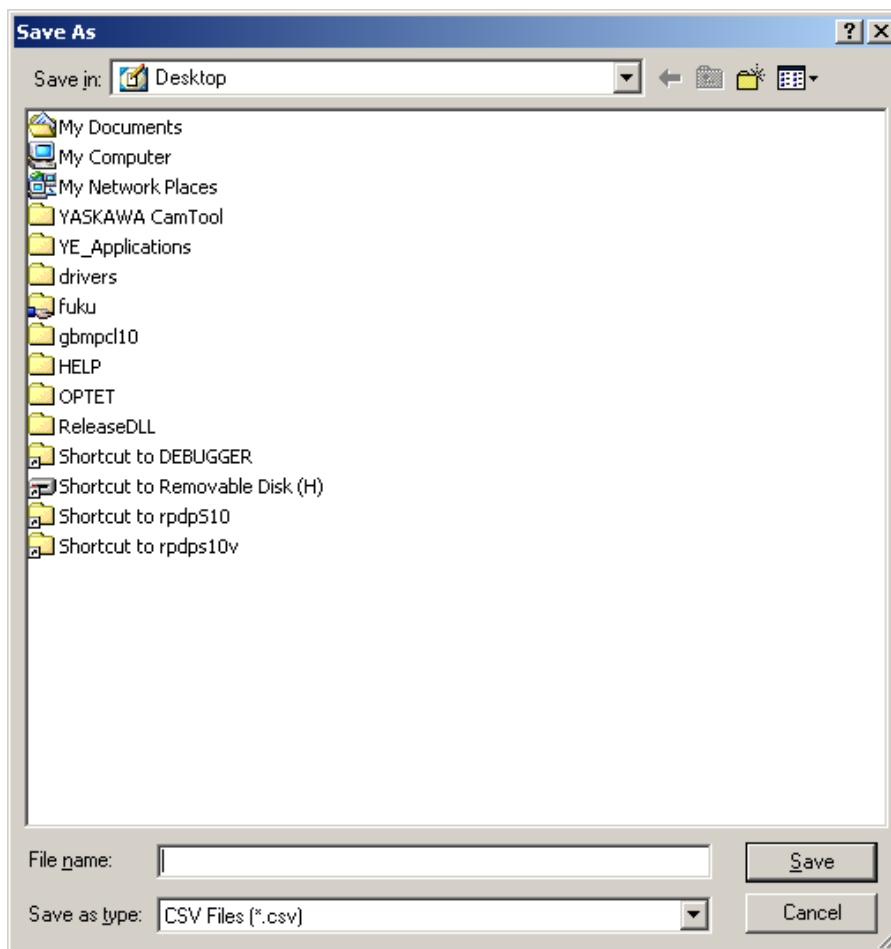

Figure 4-17 The [Save As] Dialog Box

<Sample CSV file output>

J.NET 2006/09/21 16:05:48
 Ethrer Net(158.212.99.1)

**** NET1 INFO ****

System Info
 Refresh Cycle, 30[ms]
 Status TBL Address, Unused

Station Info
 ID, Station No, Station Type, Refresh Cyc, In Byte, In Addr, Out Byte, Out Addr, Slot, LGB,
 01, 01, AUTO, 000100, 20, FW100, 20, FW200, VALID, *****,

ID 01
 Slot Info
 Slot number, I/O type, Transfer byte count, Transfer address,
 /0, DI, 20, FW100,
 /1, DO, 20, FW200,
 /2, ****, **, *****,
 /3, ****, **, *****,
 /4, ****, **, *****,
 /5, ****, **, *****,
 /6, ****, **, *****,
 /7, ****, **, *****,
 /8, ****, **, *****,
 /9, ****, **, *****,
 /A, ****, **, *****,
 /B, ****, **, *****,
 /C, ****, **, *****,
 /D, ****, **, *****,
 /E, ****, **, *****,
 /F, ****, **, *****,

**** NET2 INFO ****

System Info
 Refresh Cycle, 40[ms]
 Status TBL Address, Unused

Station Info
 ID, Station No, Station Type, Refresh Cyc, In Byte, In Addr, Out Byte, Out Addr, Slot, LGB,

This Page Intentionally Left Blank

5 PROGRAMMING

5.1 Software Configuration of the J.NET-INT

An outline of the software configuration of the J.NET-INT is shown below.

The communication program, send buffer, receive buffer, and sub-OS are ROM programs and do not need to be loaded.

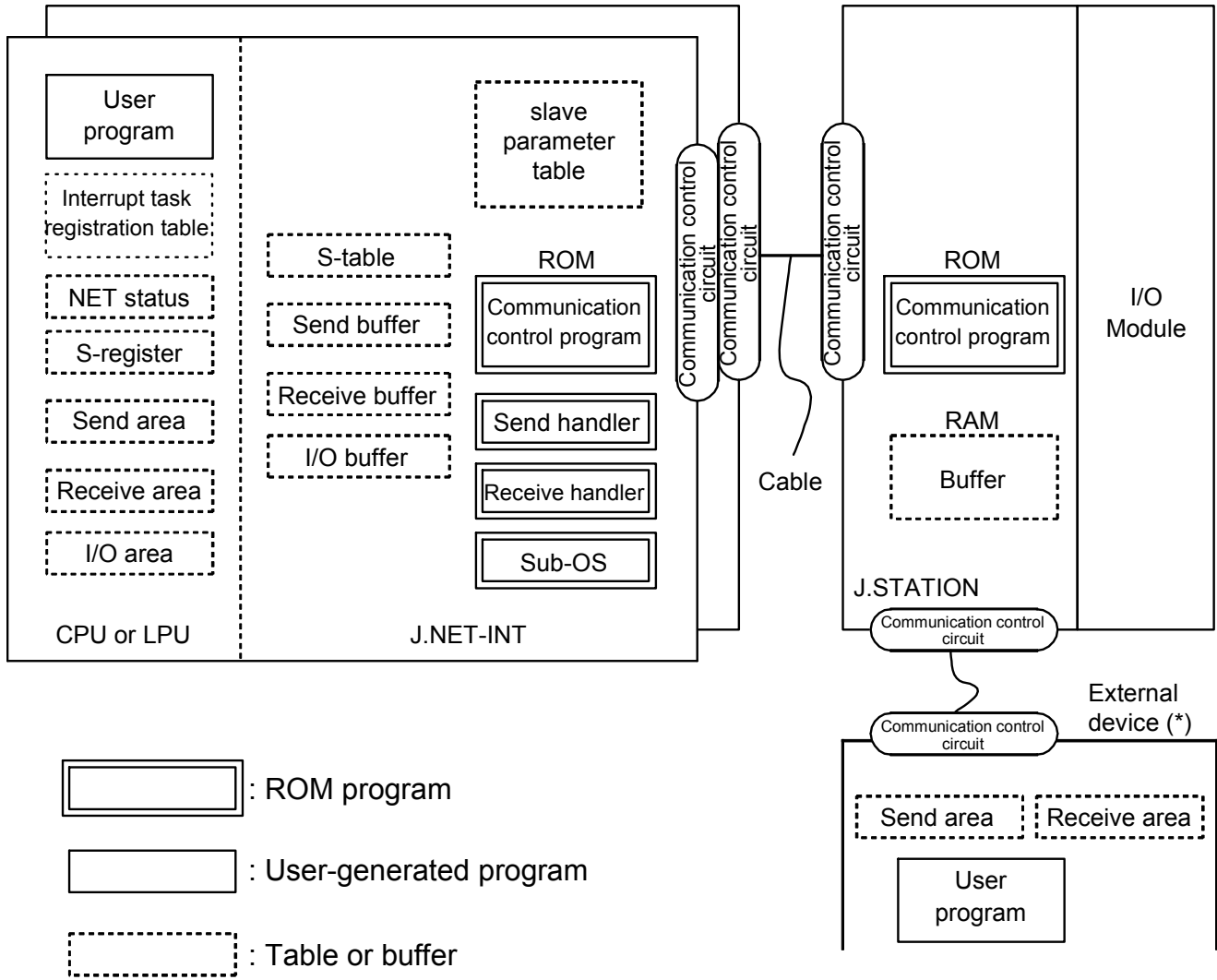

(*) Can be connected to an external device (RS-232C) as needed.

Figure 5-1 Software Configuration of the J.NET-INT

- Communication control program

The main functions are shown below.

- Executes I/O communication with an I/O unit. OFF to ON transitions on selected DI inputs cause the program to start interrupt tasks.

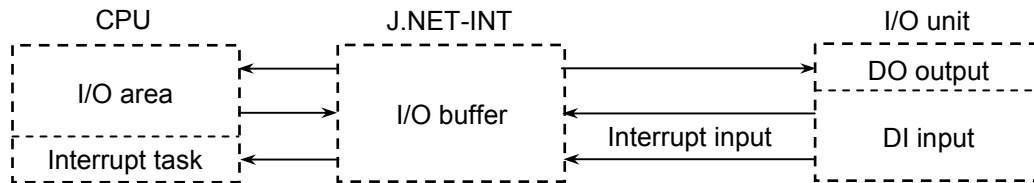

- Transmits data to and from an external device.

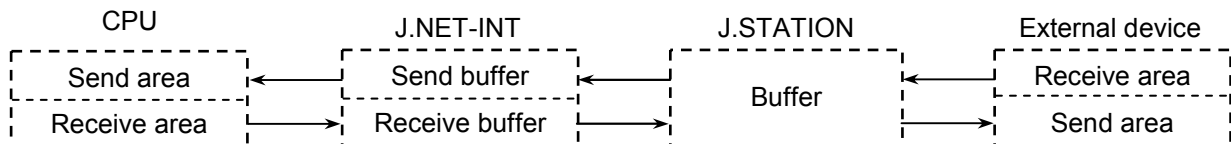

- Raises an interrupt in the CPU at the completion of data reception from an external device to start the sub-OS.

- Send handler and receive handler

Their primary functions are listed below.

- Started from a user program to request data transmission to and from the communications control program.
- Set data transmission/reception information in the NET status, S-register, and S-table.

- Sub-OS

Launched by an interrupt arising from the communications control program. Its primary function is listed below.

- Starts a receive task at the completion of data reception. (For more information on registering receive tasks, see “4.2.4 Editing NET1 information (Editing NET2 information).”)

- NET status, S-register, and S-table

These are a register and a table in which the communication control program sets data transmission/reception information and error information. User programs reference this information to transmit and receive information and handle errors.

5 PROGRAMMING

- I/O areas

The following Table 5-1 shows I/O areas that permits I/O communication.

Table 5-1 I/O Areas

Name	Symbol range	Number of points
External input	XW000 (X000) to XWFF0 (XFFF)	256 words (4,096 points)
External output	YW000 (Y000) to YWFF0 (YFFF)	256 words (4,096 points)
Internal register	RW000 (R000) to RWFF0 (RFFF)	256 words (4,096 points)
Global link register	GW000 (G000) to GWFF0 (GFFF)	256 words (4,096 points)
Transfer register	JW000 (J000) to JWFF0 (JFFF)	256 words (4,096 points)
Receive register	QW000 (Q000) to QWFF0 (QFFF)	256 words (4,096 points)
Event register	EW400 (E400) to EWFF0 (EFFF)	192 words (3,072 points)
Extended internal register	MW000 (M000) to MWFF0 (MFFF)	256 words (4,096 points)
Function work register	FW000 to FWBFF	3,072 words
Extended memory (*1)	/100000 to /4FFFFFF	2M words
Work register (*2)	LBW0000 to LBWFFF0	8,192 words (131,072 points)
Word work register (*2)	LWW0000 to LWWFFFF	65,536 words
Word work register (*2)	LXW0000 to LXW3FFF	16,384 words

(*1) Can be assigned only to an S10mini

(*2) Can be assigned only to an S10V

NOTICE

For S10mini, please confirm whether the extension memory corresponding to a set address is mounted when the address of the extension memory is set. The system performance might decrease when the extension memory corresponding to a set address is a unmounting, and mount it, please.

5.2 User-Created Programs

This section describes the software created by users to build a J.NET-INT system. The program creation procedure described in this page is not necessary if only I/O communication needs to be implemented with J.STATIONs being connected to the J.NET-INT module.

5.2.1 User programs

Handlers are activated from user programs. User programs fall into two types as follows:

- Ladder programs
Also known as “sequence programs.”
Built of an A-contact (—|—), a B-contact (—|/—), an output coil (—○—) and so forth.
- C-mode programs
Created in a computer language (such as the C-language and assembler) and run in the form of a task or P-coil. Prerequisites to using a C-mode program are:
S10mini: CPMS (Compact Process Monitor System) and extension memory
S10V: CMU module

Ladder programs start handlers form an operation function, while C-mode programs start them from a subroutine.

5.2.2 User program reception processing

When a user program finishes receiving data, the information is reflected in the relevant NET status.

If the user program is a ladder program, it would launch a receive handler (operation function) using the NET status as a trigger. Delays in fetching the received data are confined to within the sequence cycle.

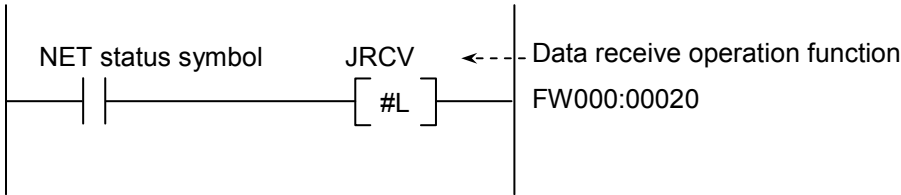

5 PROGRAMMING

If the user program is a C-mode program, monitor the NET status so as to launch a receive handler (subroutine) at the completion of data reception.

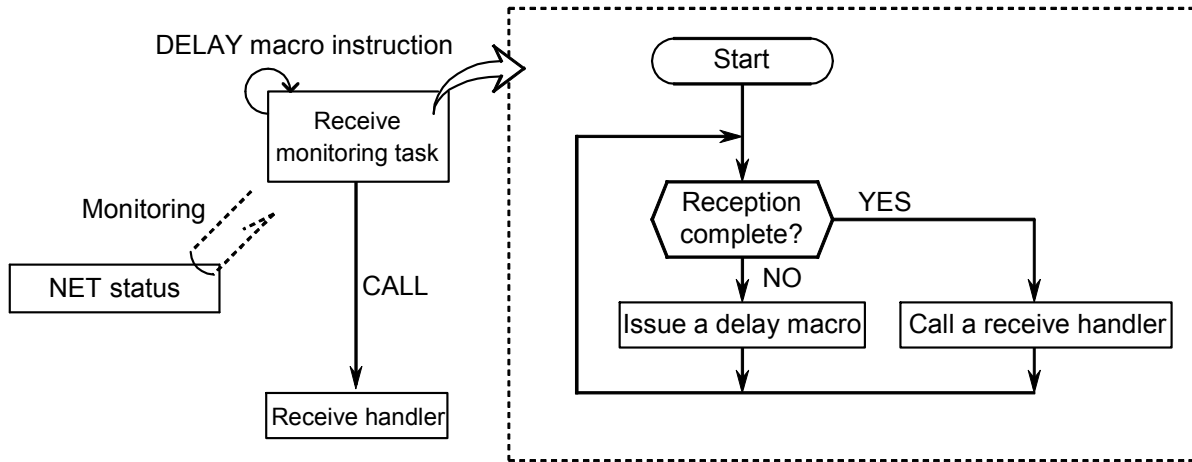

Under the scheme illustrated above, the time interval of reception completion monitoring is determined by the DELAY macro (processing macro). Consequently, the process of fetching received data could be delayed by delays in processing caused by the DELAY macro or by a lower processing level of the receive monitoring task (which is typically set low).

If the user program is a C-mode program or BASIC program, a user task needs to be created and registered that is to be launched by the sub-OS at the completion of data reception.

Such a user task would save the need for the user program to monitor the completion of data reception. Received data can thus be fetched by calling a receive handler as a subroutine from the task as it is started from the sub-OS.

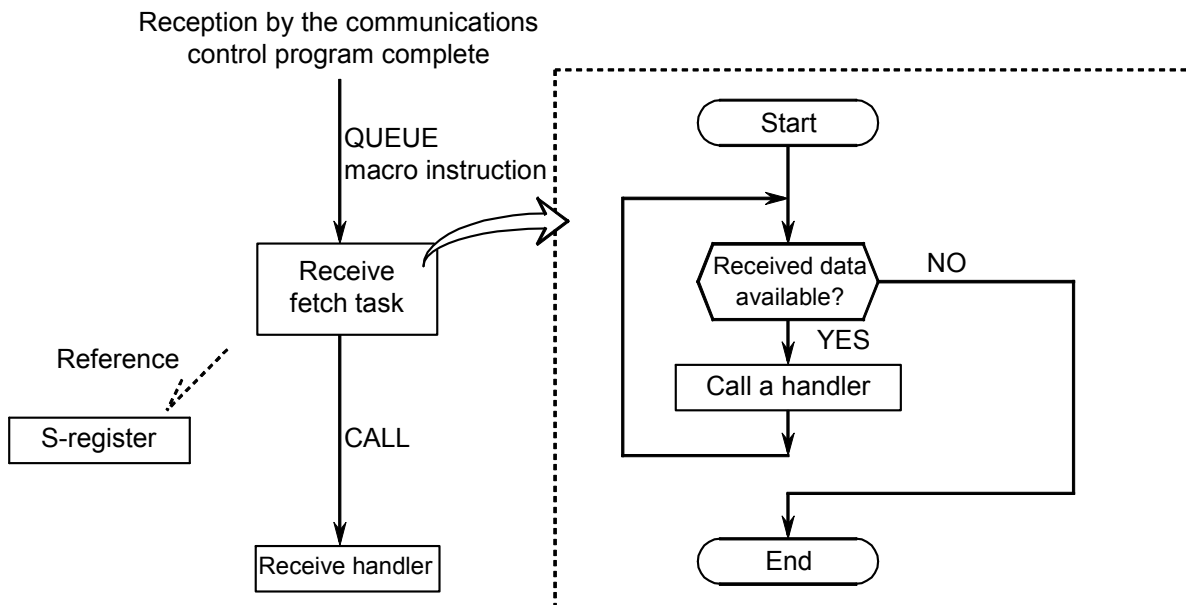

5.3 NET Status

The NET status table stores the communication information of each station. The user must register the beginning address of the NET status table from the following bit areas by the tool system. The NET status table configuration is as shown in the following table.

The registrable areas are the 9 types.

X000 to XFFF

Y000 to YFFF

J000 to JFFF

Q000 to QFFF

G000 to GFFF

R000 to RFFF

E400 to EFFF

M000 to MFFF

LB0000 to LBFFFF

One NET status table, having a capacity of 128 consecutive points, needs to be registered for N1 and N2 each. For example, if a NET status table starting at X500 is specified, then it would take up X500 to X57F, with “X5” filling up each space of $\Delta\Delta$ in the table below.

$\Delta\Delta$ denotes a registered symbol.

Station ID	Send enable flag	Data receive flag	Response receive flag	Error flag
Free	—	—	—	—
1	$\Delta\Delta 01$	$\Delta\Delta 21$	$\Delta\Delta 41$	$\Delta\Delta 61$
2	$\Delta\Delta 02$	$\Delta\Delta 22$	$\Delta\Delta 42$	$\Delta\Delta 62$
$\{$	$\{$	$\{$	$\{$	$\{$
30	$\Delta\Delta 1E$	$\Delta\Delta 3E$	$\Delta\Delta 5E$	$\Delta\Delta 7E$
31	$\Delta\Delta 1F$	$\Delta\Delta 3F$	$\Delta\Delta 5F$	$\Delta\Delta 7F$

Contents of bits	0	Transmitting	Reception of no data	Reception of no response	No error
	1	Transmission enabled	Reception of data	Reception of response	Error

5.4 S-register

The S-register stores information about errors occurring from each net (N1 and N2). It is set to 1 when any one of the stations (substations) connected to a net develops an error.

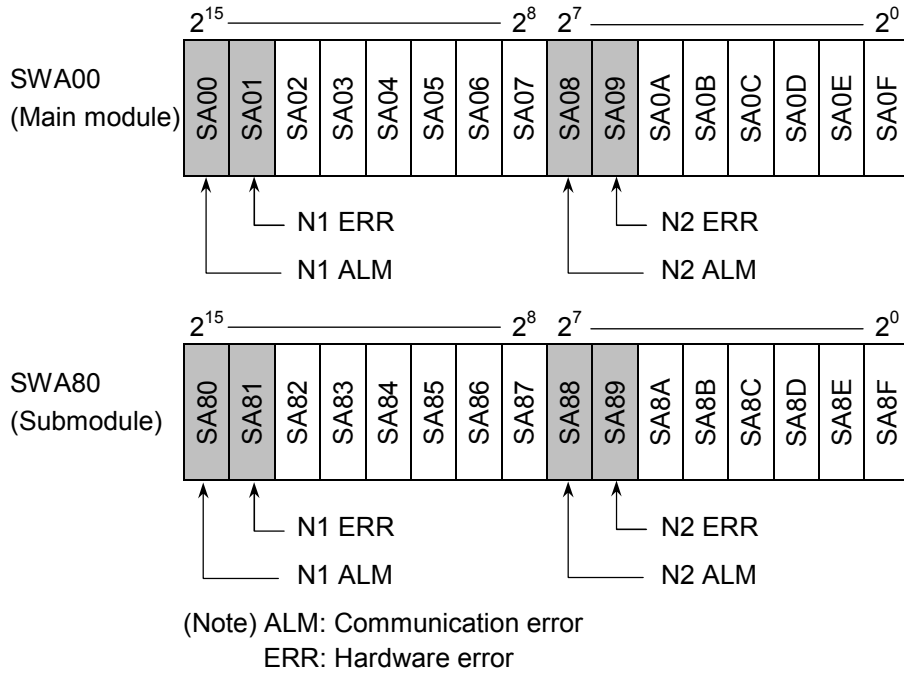

Symbol	Bit	Contents
SA00	0	The main module N1 is in normal communication.
	1	A communication error occurred in the main module N1.
SA01	0	The main module N1 is in normal operation.
	1	A hardware error occurred in the main module N1.
SA08	0	The main module N2 is in normal communication.
	1	A communication error occurred in the main module N2.
SA09	0	The main module N2 is in normal operation.
	1	A hardware error occurred in the main module N2.
SA80	0	The sub-module N1 is in normal communication.
	1	A communication error occurred in the sub-module N1.
SA81	0	The sub-module N1 is in normal operation.
	1	A hardware error occurred in the sub-module N1.
SA88	0	The sub-module N2 is in normal communication.
	1	A communication error occurred in the sub-module N2.
SA89	0	The sub-module N2 is in normal operation.
	1	A hardware error occurred in the sub-module N2.

The other bits are unused.

5.5 S-table

The S-table holds the addresses at which the byte numbers of data and responses received and the error codes arising during communication are stored. For the details of error codes, see “7.3 Errors and Countermeasures.”

Table 5-2 S-table Allocation

Net No.	Station ID	Main module		
		Number of bytes receiving data	Number of bytes receiving responses	Error code
N1	(255)	/A40000	/A40040	/A40080
	1	/A40002	/A40042	/A40082
	2	/A40004	/A40044	/A40084
	}	}	}	}
	30	/A4003C	/A4007C	/A400BC
	31	/A4003E	/A4007E	/A400BE
N2	(255)	/A40100	/A40140	/A40180
	1	/A40102	/A40142	/A40182
	2	/A40104	/A40144	/A40184
	}	}	}	}
	30	/A4013C	/A4017C	/A401BC
	31	/A4013E	/A4017E	/A401BE

Net No.	Station ID	Submodule		
		Number of bytes receiving data	Number of bytes receiving responses	Error code
N1	(255)	/AC0000	/AC0040	/AC0080
	1	/AC0002	/AC0042	/AC0082
	2	/AC0004	/AC0044	/AC0084
	}	}	}	}
	30	/AC003C	/AC007C	/AC00BC
	31	/AC003E	/AC007E	/AC00BE
N2	(255)	/AC0100	/AC0140	/AC0180
	1	/AC0102	/AC0142	/AC0182
	2	/AC0104	/AC0144	/AC0184
	}	}	}	}
	30	/AC013C	/AC017C	/AC01BC
	31	/AC013E	/AC017E	/AC01BE

5.6 Handlers

The J.NET-INT module makes two types of handlers available to user programs: operation functions and subroutines.

5.6.1 Operation functions

The operation functions are grouped into four types as listed below.

Name	Function	Remarks
JCMD	Service request operation function. Issues data write services (READ/WRITE commands), a RESET service, and a broadcast service.	RESET command, broadcast command, READ command, and WRITE command
JRSP	Service confirmation operation function. Fetches the data received by issuing a READ command into a specified area.	READ command only
JSND	Data send operation function. Transmits data from a J.STATION RS-232C port to the external device connected to the J.STATION.	Can be issued to J.STATIONs only.
JRCV	Data receive operation function. Fetches the data received on an J.STATION RS-232C port from the external device connected to the J.STATION.	Can be issued to J.STATIONs only.

NOTICE

Before using an operation function, register it using the tool system. For information on how to register operation functions, see “4.2.9 Registering user operation functions (S10mini).” This function is not available on the [S10V] J.NET system, because user operation functions are preregistered with the S10V.

(1) Operation function basic format

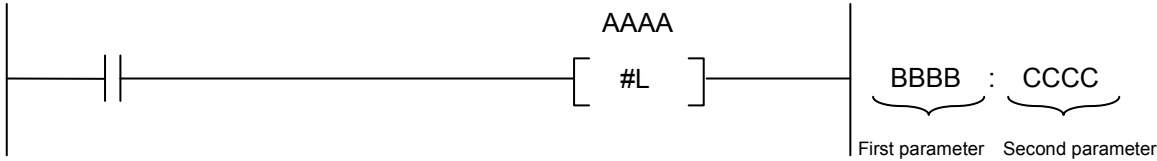

- Operation function name
Choose one from among JCMD, JRSP, JSND, and JRCV.
- First parameter
Set the starting address of a send or receive area. Only a symbol, such as FW000, can be entered. Numeric data, such as an extended memory address, cannot be entered.
- Second parameter
Set the data length of a send or receive area in bytes. The setting range varies with each operation function.

JCMD	4 to 254 bytes
JRSP	4 to 254 bytes
JSND	4 to 516 bytes
JRCV	4 to 516 bytes

(2) Format of the send/receive area for JCMD (except for the READ/WRITE commands), JRSP, JSND, and JRCV

	2^{15} —	2^8	2^7 —	2^0
0	MDL		SID	
2	NET		SVC	
4	Data 1		Data 2	
6	Data 3		⋮	
	⋮		⋮	
	⋮		Data N	

MDL: Module number (/00: main, /01: sub)
 SID: Station ID (/01 to /1F)
 NET: Net number (/00: N1, /01: N2)
 SVC: Service code

SVC	Service name
/31	Reset service
/32	Data write service
/33	Broadcast service

Data 1 to N: Dependent on each operation function.

5 PROGRAMMING

(3) Format of the send/receive area for JCMD (READ/WRITE commands)

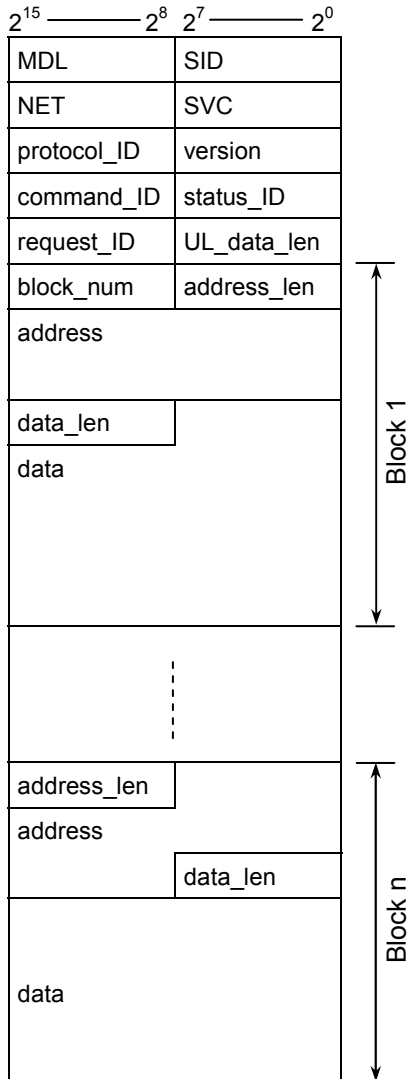

MDL: Module number (/00: main, /01: sub)

SID: Station ID (/01 to /1F)

NET: Net number (/00: N1, /01: N2)

SVC: Service code (/32: data write service)

protocol_ID: Set whether a protocol is registered or not.

Set "/00."

version: Set a protocol version number.

Set "/00."

command_ID: Set a protocol-specific command identification code.

Set "/11" for the WRITE command or "/12" for the READ command.

status_ID: Indicates a response to the command.

Set "/00" when transmitting a command.

request_ID: Command sequence identification data that is held until the service completes.

UL_data_len: Set the byte number of UL_data.

block_num: Set the byte number of the data that follows block_num.

address_len: Set the byte number of the address field.

address: Set the transmission/reception address from the low-order byte upward.

data_len: Set the byte number of the data field.

data: Indicates transmitted or received data.

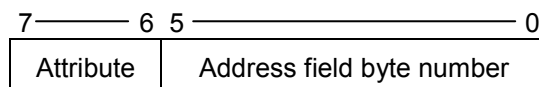

Attribute	Explanation
/00	Address field symbol (character string)
/01	Address field numeric
/10	Not used (Do not set)
/11	

JCMD: WRITE command

[Function] Transmits a parameter-specified command.

[Status information] Transmission/reception information status and error information are stored in the S-register, the NET status table, and the S-table.

[Sample program 1] A sample run of the WRITE command that writes 8 bytes of data to substation addresses /24000 to 7 with a NET status table covering Q000 to Q07F is shown below.

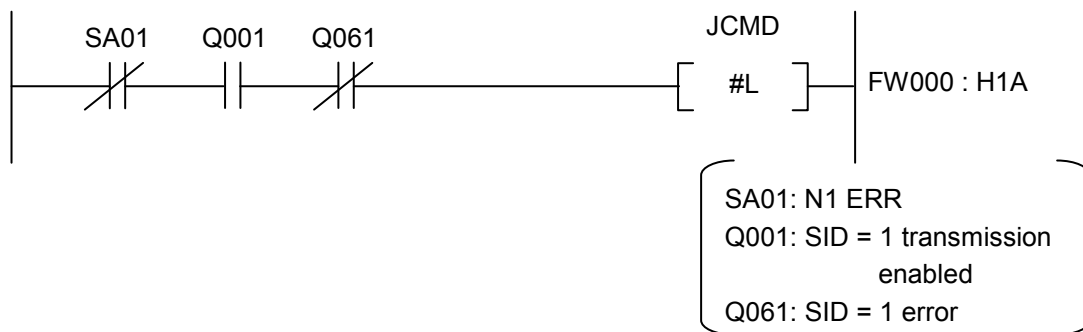

[Transfer area configuration data]

Starting address specified with the first parameter

FW000	①mdl(/00)	②sid(/01)
1	③net(/00)	④svc(/32)
2	⑤protocol_ID(/00)	⑥version(/00)
3	⑦command_ID(/11)	⑧status_ID(/00)
4	⑨request_ID(/00)	⑩UL_data_len(/0F)
5	⑪block_num(/01)	⑫address_len(/44)
6	⑬address(/00)	⑭address(/40)
7	⑮address(/02)	⑯address(/00)
8	⑰data_len(/08)	⑱data1(/12)
9	⑲data2(/34)	⑳data3(/56)
A	㉑data4(/78)	㉒data5(/9A)
B	㉓data6(/BC)	㉔data7(/DE)
C	㉕data8(/F0)	㉖00

Number of bytes specified with the second parameter

- ①mdl: Set a module number (/00: main, /01: sub).
- ②sid: Set a station ID.
- ③net: Set a net number.
- ④ to ⑨: Set the fixed values specified at left.
- ⑩UL_data_len: Set the byte number of the data that follows block_num 11.
- ⑪block_num: Set "/01" since there is only one block available.
- ⑫address_len: Set "/44" since address /00024000 is a 4-byte value.
- ⑬ to ⑯address: Set from the low-order byte upward, in the order of 00, 40, 02 and 00, since the address is /000240000.
- ⑰data_len: Set the byte number of data transmitted (byte number of data 18 to 25).

(Note 1) The values in parentheses above are examples of configuration data.

(Note 2) Shaded configuration data above denotes fixed values.

5 PROGRAMMING

JCMD: READ command

[Sample program 2] A sample run of the READ command that reads 8 bytes of data from substation addresses /24000 to 7 with a NET status table covering Q000 to Q07F is shown below.

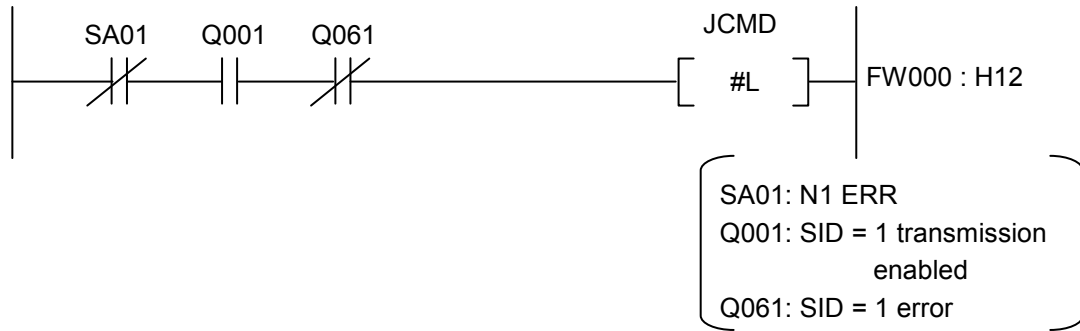

[Transfer area configuration data]

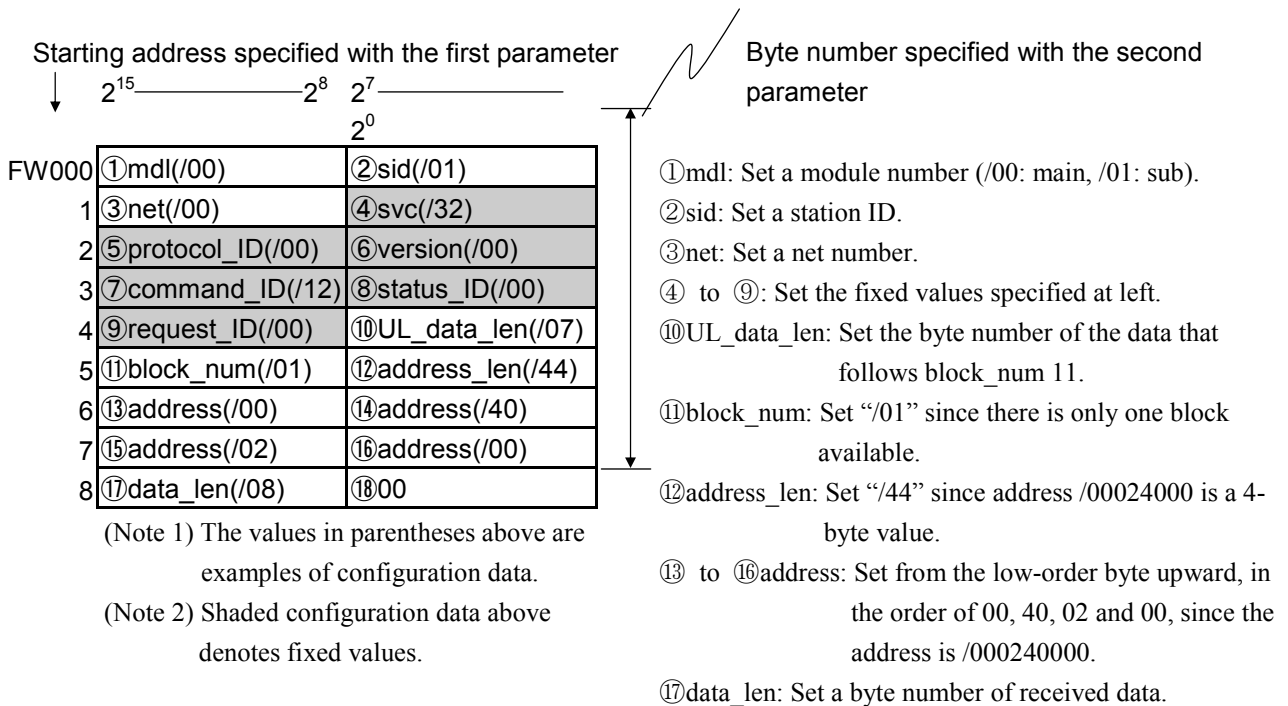

JCMD: RESET command

[Sample program 3] A sample run of the RESET command with a NET status table covering Q000 to Q07F is shown below.

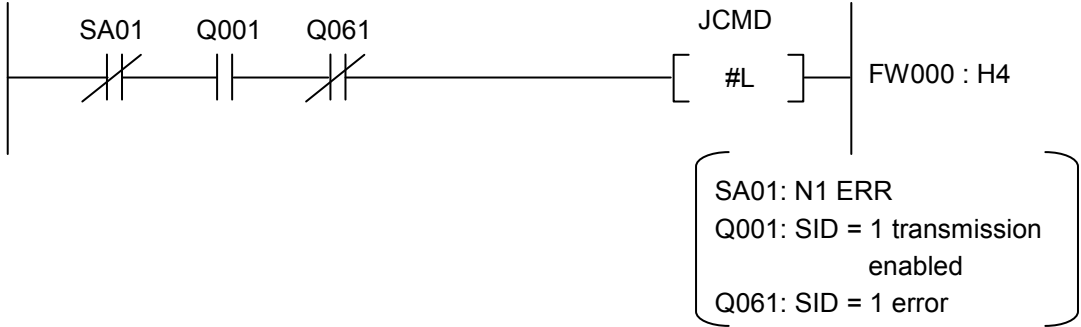

[Transfer area configuration data]

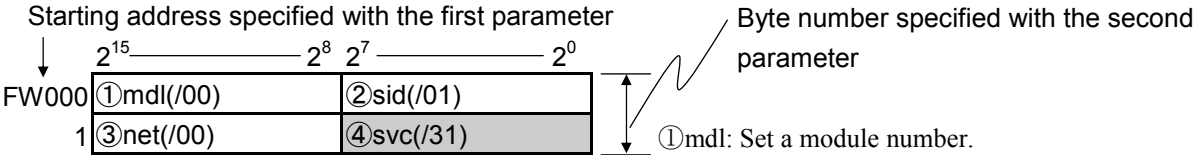

(Note 1) The values in parentheses above are examples of configuration data.

(Note 2) Shaded configuration data above denotes fixed values.

- ①mdl: Set a module number.
- ②sid: Set a station ID.
- ③net: Set a net number.
- ④svc: Set the fixed values specified at left.

5 PROGRAMMING

JCMD: Broadcast command

[Sample program 4] A sample run of the broadcast command with a NET status table covering Q000 to Q07F is shown below.

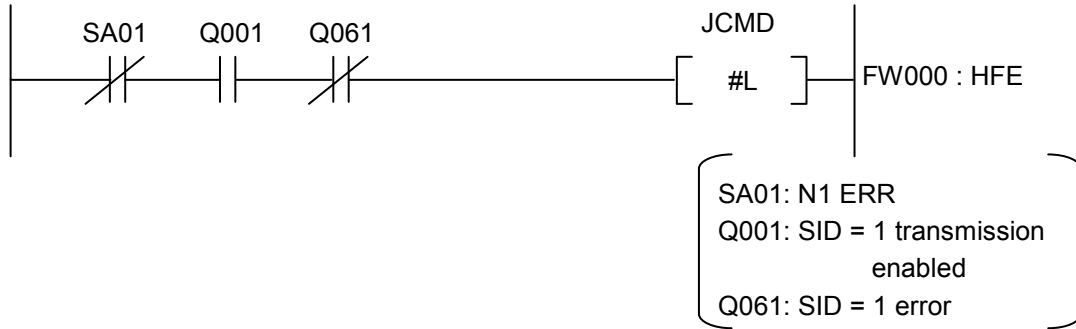

[Transfer area configuration data]

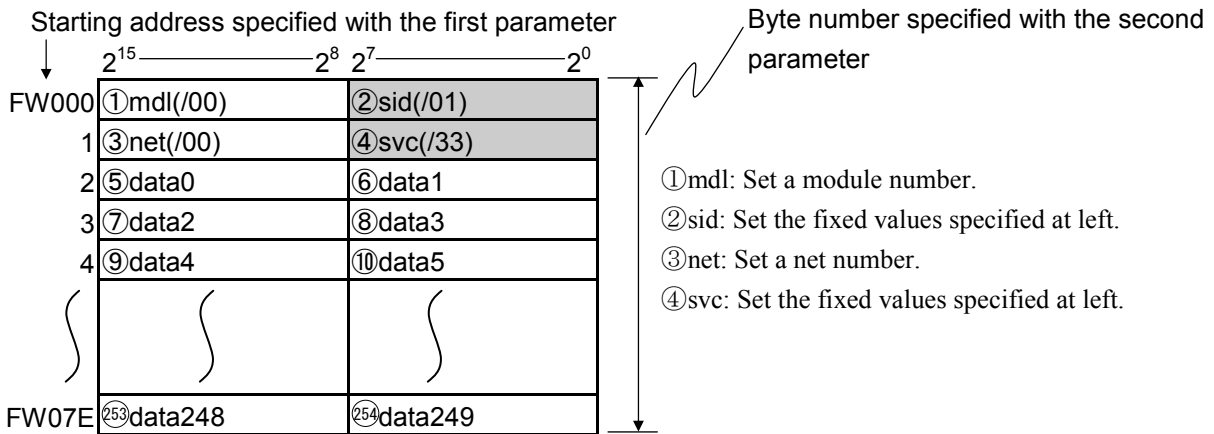

(Note 1) The values in parentheses above are examples of configuration data.

(Note 2) Shaded configuration data above denotes fixed values.

JRSP

[Function] Fetches the data that has been buffered in the J.NET-INT buffer by issuing a JCMD READ command into a user-specified area.

[Status information] Transmission/reception information status and error information are stored in the S-register, the NET status table, and the S-table.

[Sample program] A sample run of JRSP that fetches the response data that has been received from a substation by issuing a JCMD READ command with a NET status table covering Q000 to Q07F into FW080 to FW086 is shown below.

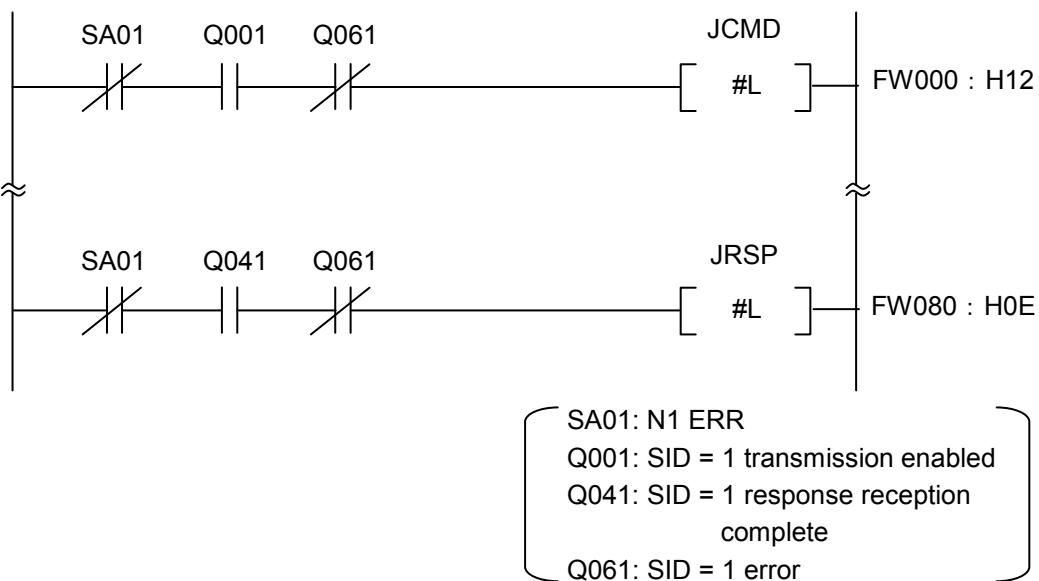

[Transfer area configuration data]

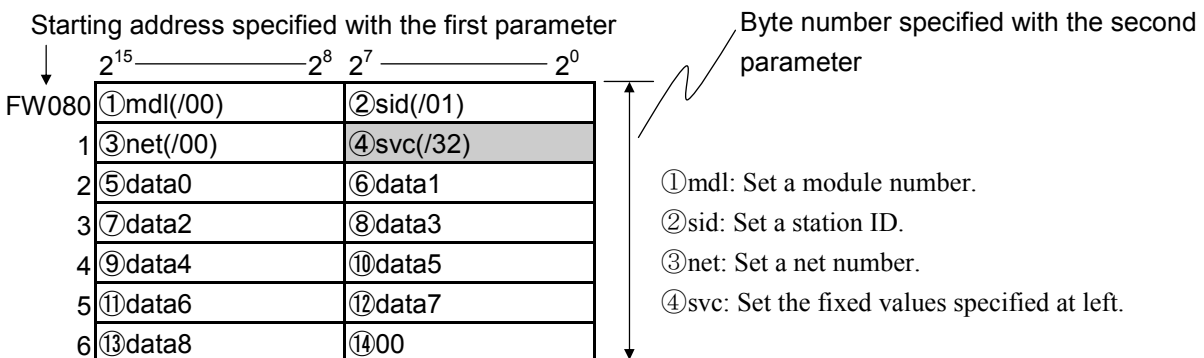

(Note 1) The values in parentheses above are examples of configuration data.

(Note 2) Shaded configuration data above denotes fixed values.

5 PROGRAMMING

JSND

- [Function] Transmits a specified byte number of data from a parameter-specified send area to the external device connected to a J.STATION.
- [Status information] Transmission/reception information status and error information are stored in the S-register, the NET status table, and the S-table.
- [Sample program] With a NET status table covering Q000 to Q07F having LGB configured, a sample transmission of 128 bytes of data from FW000 to the external device connected to a J.STATION is shown below. (Because the byte number specified by the second parameter has mdl, etc. attached to it, be sure to increment the transmitted data length by 4 bytes.)

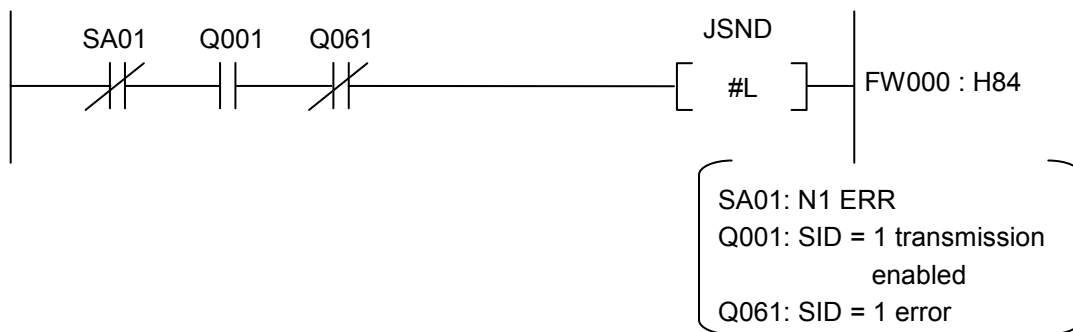

[Transfer area configuration data]

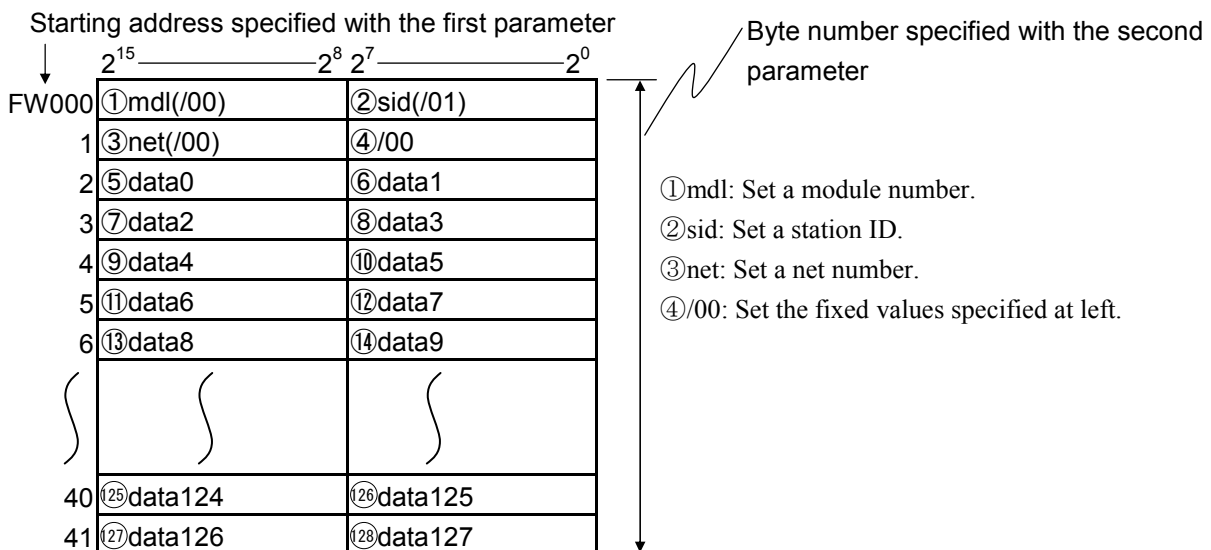

JRCV

[Function] Receives in a parameter-specified receive area a specified byte number of data from the external device connected to a J.STATION.

[Status information] Transmission/reception information status and error information are stored in the S-register, the NET status table, and the S-table.

[Sample program] With a NET status table covering Q000 to Q07F having LGB configured, a sample fetch of 32 bytes of data from FW100 received from the external device connected to a J.STATION is shown below. (Because the byte number specified by the second parameter has mdl, etc. attached to it, be sure to increment the received data length by 4 bytes.)

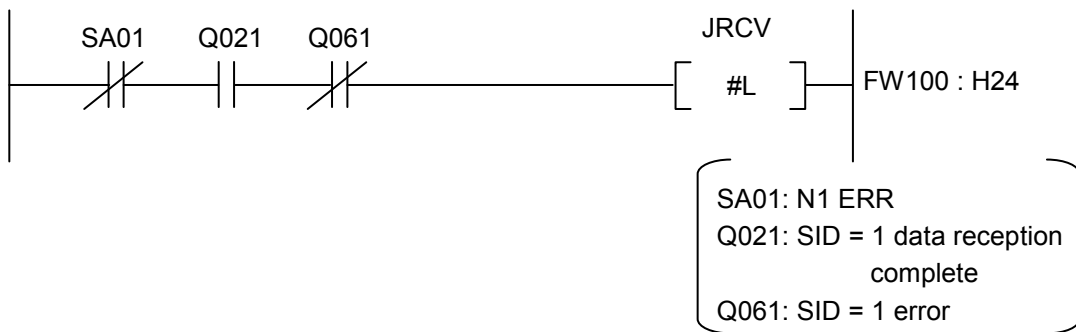

[Transfer area configuration data]

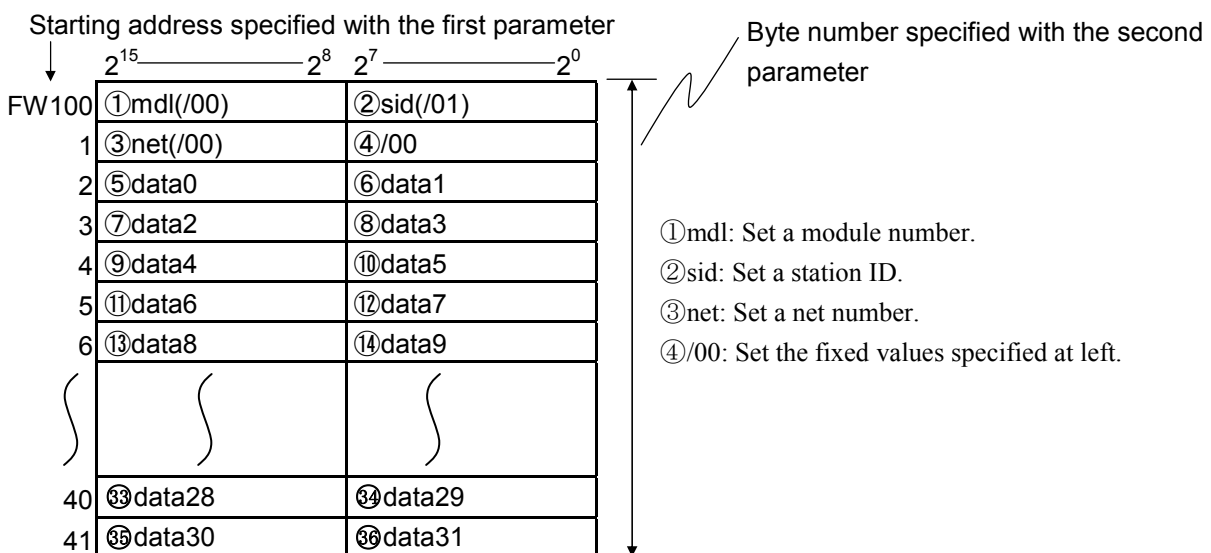

5 PROGRAMMING

5.6.2 Subroutines

Like operation functions, subroutines are grouped into four types as listed below.

Table 5-3 Subroutine Types

Name	Function	Link address	
		S10mini	S10V
J_CMD	Service request subroutine. Issues data write services (READ/WRITE commands), a RESET service, and a broadcast service.	/A0040C	/A740C0
J_RSP	Service subroutine. Fetches the data received by issuing a READ command into a specified area.	/A00412	/A740E0
J_SND	Data send operation subroutine. Transmits data from a J.STATION RS-232C port to the external device connected the J.STATION.	/A00400	/A74080
J_RCV	Data receive subroutine. Fetches the data received on a J.STATION RS-232C port from the external device connected to the J.STATION.	/A00406	/A740A0

User programs are written in the C-language. (With the S10mini, the 68,000 assembler language may be used as well.)

Because J.NET-INT module handlers (subroutines) are called by addressing from a user program, they cannot be created (linked) in such form that they are included in a user program.

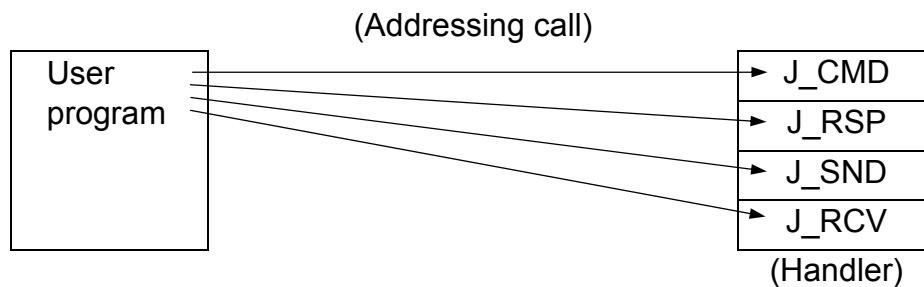

If the J.NET-INT module (LQE545) is mounted in an S10V LPU unit, module Rev. B (Ver-Rev: 0002-0001) and earlier modules would not have access to the function of sending and receiving data from C-mode handlers (subroutines); they can only use operation functions. To use C-mode handlers (subroutines) with an S10V LPU unit, module Rev. C (Ver-Rev: 0003-0000) and later modules must be used.

The "Ver-Rev" is the version-revision number of the microprogram of the J.NET-INT module indicated in "Module List" in the S10V BASE SYSTEM.

J_CMD

[Function] Transmits a parameter-specified command.

[Link procedure] The addresses listed in the table below are used when the J.NET-INT module is used in conjunction with an S10mini CPU. For the addresses that are used when the J.NET-INT module is used in conjunction with an S10V, see Table 5-3.

C-language	Assembler language (S10mini only)
long (*j_cmd);	movea.l #0xa0040c,a0
long rtn;	movea.l #para,-(sp)
struct para *para;	jsr (a0)
:	addq.l #4,sp
j_cmd=0xa0040c;	:
rtn=(*j_cmd)(para);	para:
:	<i>Parameter</i>

NOTICE

- With the assembler language, the validity of the contents of any register other than the D0 register (return code storage) would be guaranteed. (The C-language need not be register-conscious.)
- Subroutine J_CMD uses 128 bytes of user program stack space.

[Parameters]

```
struct para {
  unsigned char mdl; /*Module number (0 = main, 1 = sub) */
  unsigned char sid; /*Station ID (/01 to /1F) */
  unsigned char net; /*Net number (0=N1, 1=N2) */
  unsigned char svc; /*Service code */
  unsigned long adr; /*Transmitted data starting address */
  unsigned short len; /*Transmitted data byte number (/01 to /FA) */
};
```

With the S10V, specify an integral multiple of 4 as the starting address of parameter para. With the S10V, specify an even address as adr (starting address of transmitted data).

Service code /31: Reset service
 /32: Data write service
 /33: Broadcast service

Transmitted data Data part of JEM-F3008

5 PROGRAMMING

[Return code]

/00000000: Normal end

/FFFFFFFF: Abnormal end

Error information is stored in the error code in the S-table and in the error flag in the NET status.

/80000000: Input parameter error

An error would be flagged if parameter mdl, sid, net, svc, or len is out of bounds or the SVPT (Slave Parameter Table) station number is undefined.

[Note]

long (*j_cmd)(); A declaration of function f, which is returned as a function value of a pointer to a double-precision integer.

J_RSP

[Function] Fetches a specified byte number of response data that has been received from a substation by issuing a J_CMD READ command into a parameter-specified area.

[Link procedure] The addresses listed in the table below are used when the J.NET-INT module is used in conjunction with an S10mini CPU. For the addresses that are used when the J.NET-INT module is used in conjunction with an S10V, see Table 5-3.

C-language	Assembler language (S10mini only)
<pre>long (*j_rsp)(); long rtn; struct para *para; : j_rsp=0xa00412; rtn=(*j_rsp)(para); :</pre>	<pre>movea.l #a00412,a0 movea.l #para,-(sp) jsr (a0) addq.l #4,sp : para: <i>Parameter</i></pre>

NOTICE

- With the assembler language, the validity of the contents of any register other than the D0 register (return code storage) would be guaranteed. (The C-language need not be register-conscious.)
- Subroutine J_RSP uses 128 bytes of user program stack space.

[Parameters]

```
struct para {
    unsigned char mdl; /*Module number (0 = main, 1 = sub) */
    unsigned char sid; /*Station ID (/01 to /1F) */
    unsigned char net; /*Net number (0=N1, 1=N2) */
    unsigned char svc; /*Service code */
    unsigned long adr; /*Transmitted data starting address */
    unsigned short len; /*Transmitted data byte number (/01 to /FA) */
};
```

With the S10V, specify an integral multiple of 4 as the starting address of parameter para.

With the S10V, specify an even address as adr (starting address of transmitted data).

Service code /32: Data write service

5 PROGRAMMING

[Return code]

/00000000: Normal end

The response receive flag in the NET status remains ON (receive data available) if there still remains data yet to be fetched after a data fetch.

/00000001: No receive data is available in the receive buffer.

/001A0000: Last data has been encountered in the buffer while fetching received data.

Data has been received in a byte number equal to or less than the parameter-specified number.

/FFFFFFFF: Abnormal end

Error information is stored in the error code in the S-table and in the error flag in the NET status.

/80000000: Input parameter error

An error would be flagged if parameter mdl, sid, net, svc, or len is out of bounds or the SVPT (Slave Parameter Table) station number is undefined.

[Note]

If data has been received in a byte number less than the parameter-specified number, the received data area is padded with /00 at positions after the received data. In the example shown below, 6 bytes of data have been actually received against a received data byte number setting of 10 bytes.

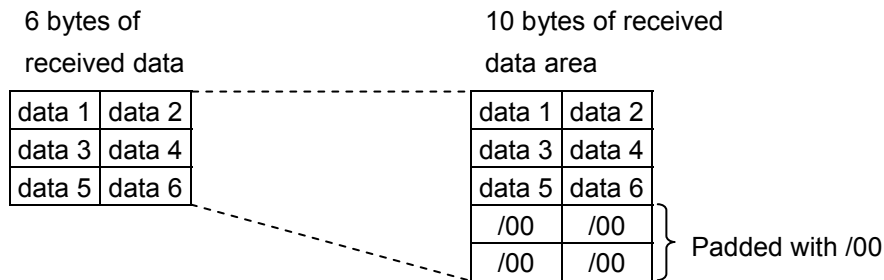

J_SND

[Function] Transmits a specified byte number of data from a parameter-specified send area to the external device connected to the J.STATION.

[Link procedure] The addresses listed in the table below are used when the J.NET-INT module is used in conjunction with an S10mini CPU. For the addresses that are used when the J.NET-INT module is used in conjunction with an S10V, see Table 5-3.

C-language	Assembler language (S10mini only)
long (*j_snd)();	movea.l #\$a00400,a0
long rtn;	movea.l #sr_para,-(sp)
struct sr_para *padr;	jsr (a0)
:	addq.l #4,sp
j_snd=0xa00400;	:
rtn=(*j_snd)(padr);	sr_para:
:	<i>Parameter</i>

NOTICE

- With the assembler language, the validity of the contents of any register other than the D0 register (return code storage) would be guaranteed. (The C-language need not be register-conscious.)
- Subroutine J_SND uses 128 bytes of user program stack space.
- Because data transmission by subroutine J_SEND takes place in synch with the I/O service, it affects the I/O service refresh cycle.

[Parameters]

```
struct sr_para {
  unsigned char mdl; /*Module number (0 = main, 1 = sub) */
  unsigned char sid; /*Station ID (/01 to /1F) */
  unsigned char net; /*Net number (0=N1, 1=N2) */
  unsigned char svc; /*Vacant */
  unsigned long adr; /*Transmitted data starting address */
  unsigned short len; /*Transmitted data byte number (/01 to /200) */
};
```

With the S10V, specify an integral multiple of 4 as the starting address of parameter padr.
With the S10V, specify an even address as adr (starting address of transmitted data).

5 PROGRAMMING

[Return code]

/00000000: Normal end

/FFFFFFFF: Abnormal end

Error information is stored in the error code in the S-table and in the error flag in the NET status.

/80000000: Input parameter error

An error would be flagged if parameter mdl, sid, net, svc, or len is out of bounds or the SVPT (Slave Parameter Table) station number is undefined.

J_RCV

[Function] Receives in a parameter-specified receive area a specified byte number of data from the external device connected to a J.STATION.

[Link procedure] The addresses listed in the table below are used when the J.NET-INT module is used in conjunction with an S10mini CPU. For the addresses that are used when the J.NET-INT module is used in conjunction with an S10V, see Table 5-3.

C-language	Assembler language (S10mini only)
<pre>long (*j_rcv)(); long rtn; struct sr_para *padr; : j_rcv=0xa00406; rtn=(*j_rcv)(padr); :</pre>	<pre>movea.l #\$a00406,a0 movea.l #sr_para,-(sp) jsr (a0) addq.l #4,sp : sr_para: <i>Parameter</i></pre>

NOTICE

- With the assembler language, the validity of the contents of any register other than the D0 register (return code storage) would be guaranteed. (The C-language need not be register-conscious.)
- Subroutine J_RCV uses 128 bytes of user program stack space.

[Parameters]

```
struct sr_para {
    unsigned char mdl; /*Module number (0 = main, 1 = sub) */
    unsigned char sid; /*Station ID (/01 to /1F) */
    unsigned char net; /*Net number (0=N1, 1=N2) */
    unsigned char svc; /*Vacant */
    unsigned long adr; /* Received data starting address */
    unsigned short len; /* Byte number of received data (/01 to /200) */
};
```

With the S10V, specify an integral multiple of 4 as the starting address of parameter padr.

With the S10V, specify an even address as adr (starting address of transmitted data).

5 PROGRAMMING

[Return code]

/00000000: Normal end

The response receive flag in the NET status remains ON (receive data available) if there still remains data yet to be fetched after a data fetch.

/00000001: No receive data is available in the receive buffer.

/001A0000: Last data has been encountered in the buffer while fetching received data.

Data has been received in a byte number equal to or less than the parameter-specified number.

/FFFFFFFF: Abnormal end

Error information is stored in the error code in the S-table and in the error flag in the NET status.

/80000000: Input parameter error

An error would be flagged if parameter mdl, sid, net, svc, or len is out of bounds or the SVPT (Slave Parameter Table) station number is undefined.

[Note]

If data has been received in a byte number less than the parameter-specified number, the received data area is padded with /00 at positions after the received data. In the example shown below, 6 bytes of data have been actually received against a received data byte number setting of 10 bytes.

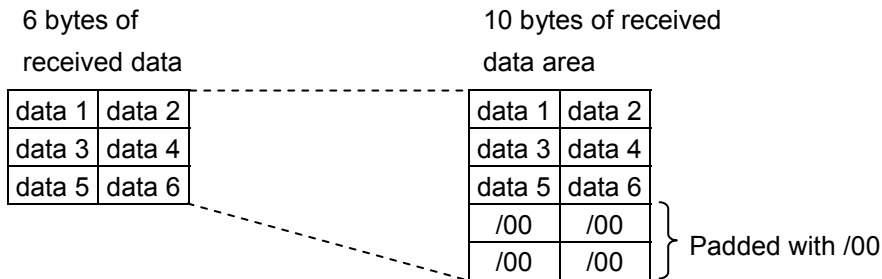

5.7 Command/Response Buffer

● Command buffer

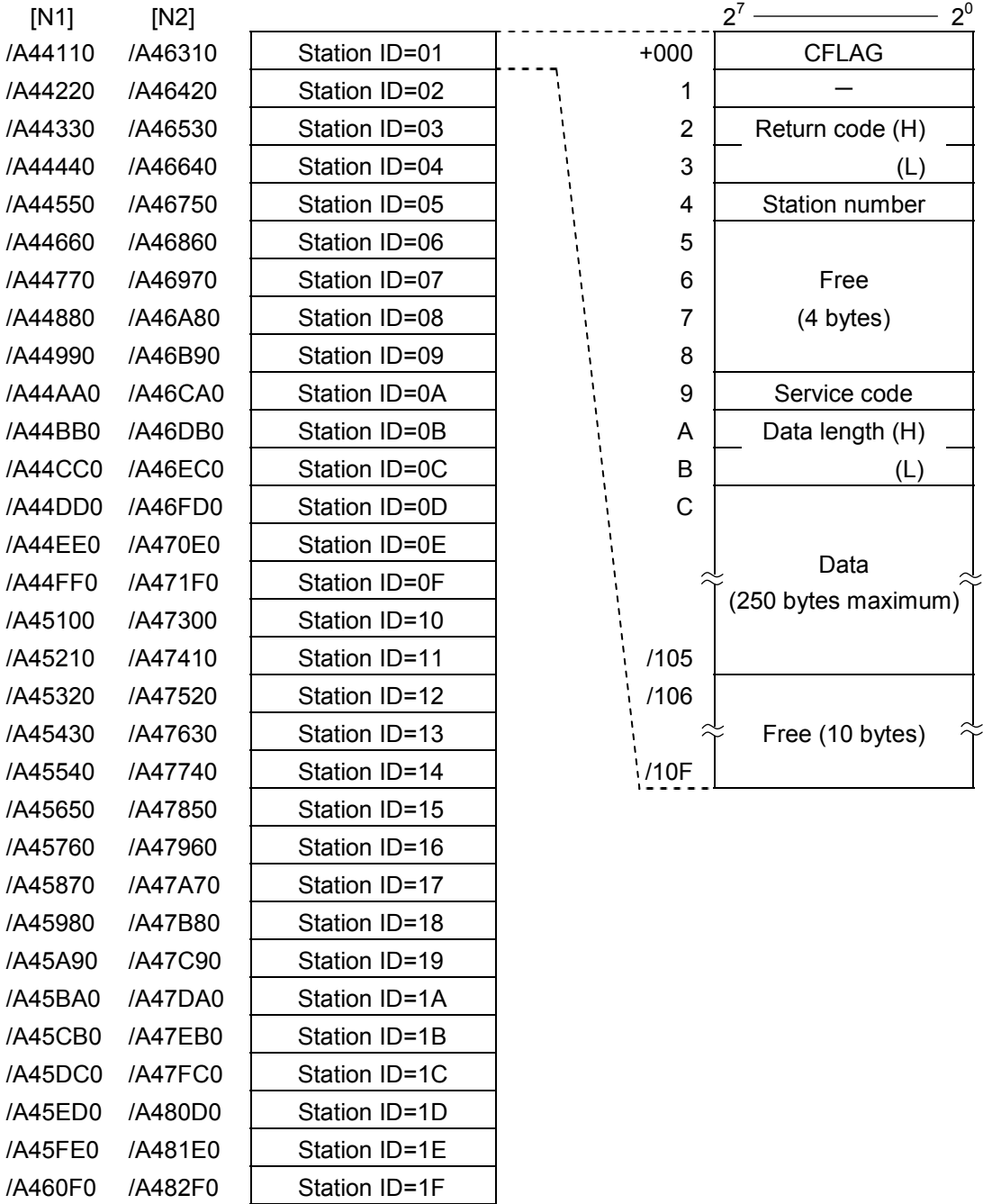

5 PROGRAMMING

● Response buffer

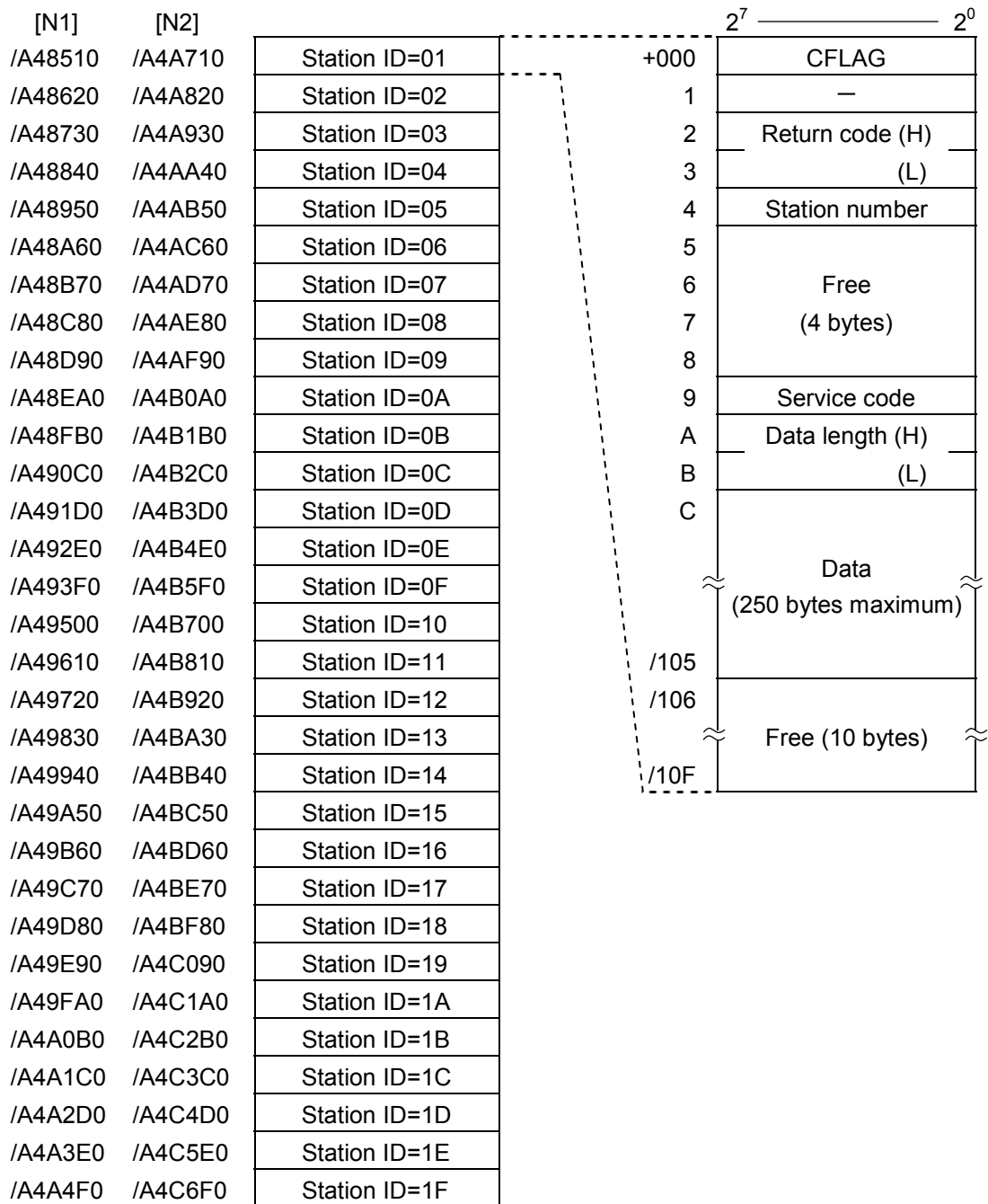

5.8 Data Send/Receive Buffer

● Send buffer

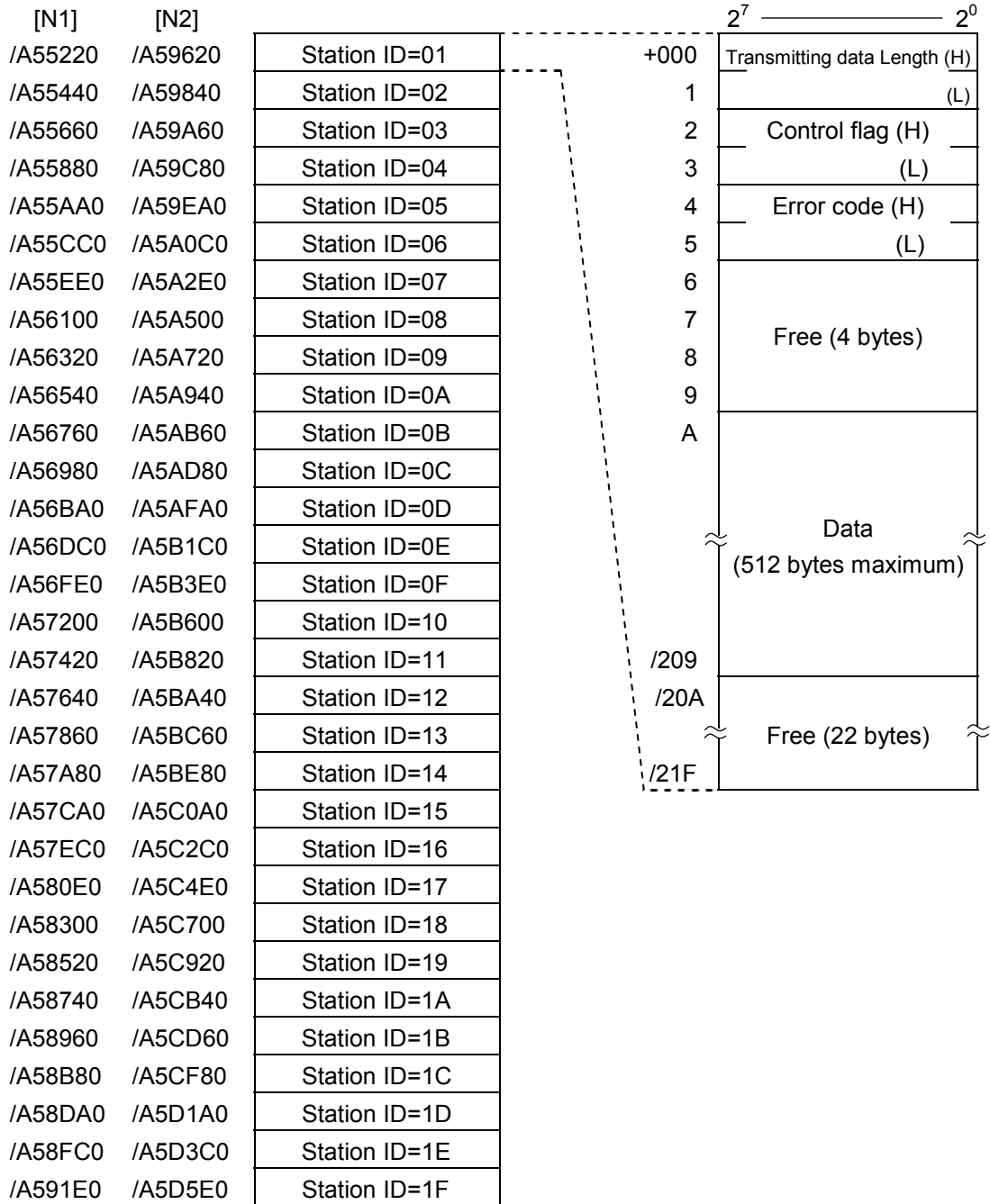

5 PROGRAMMING

● Receive buffer

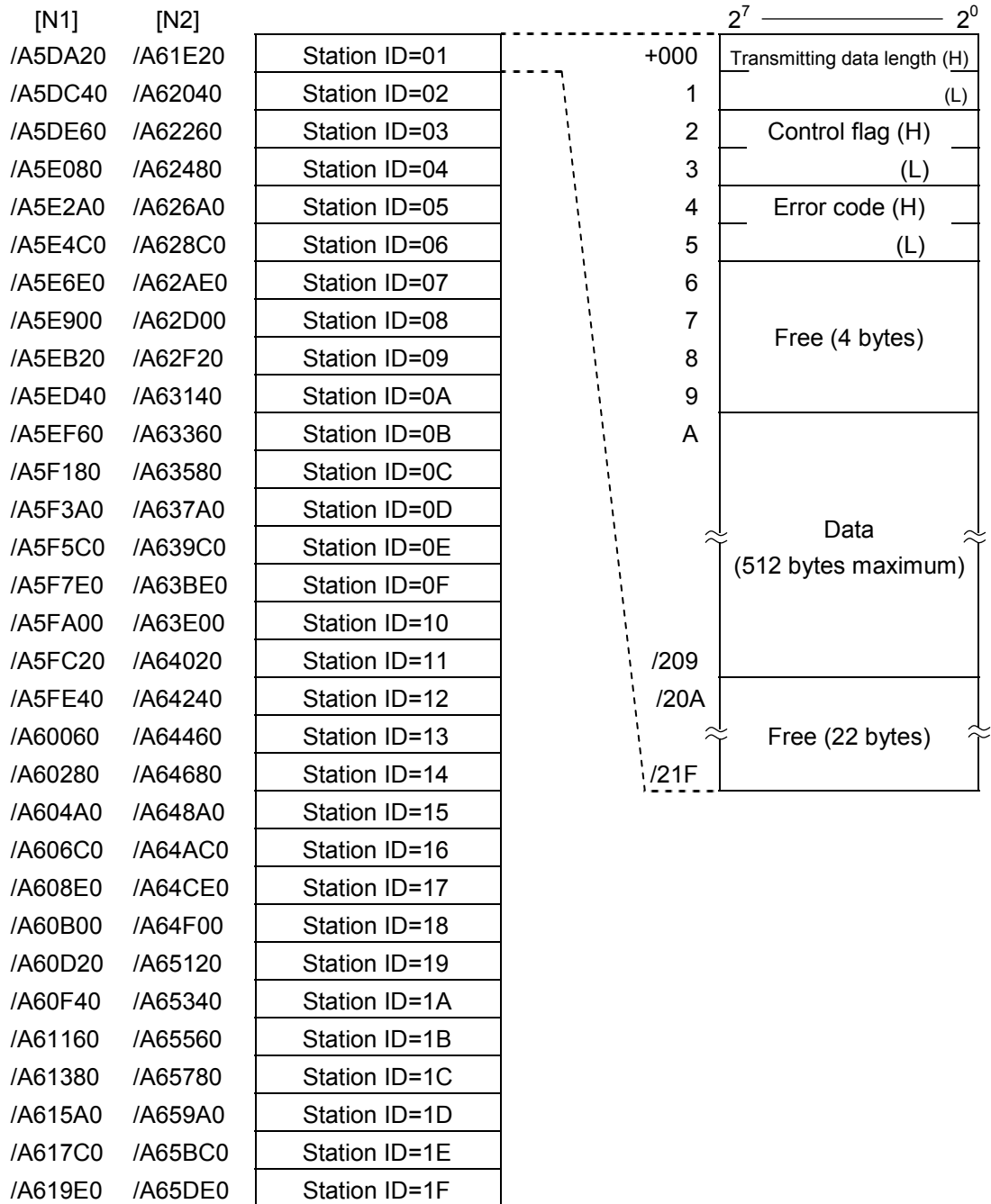

6 USER GUIDE

6.1 JEMA Standard Compliance

The JEMA standard provides for the communication services listed below. This section describes the J.NET-INT communication commands and functions that support these services.

JEMA standard service name	J.NET-INT command name	Function
Initialization service	Issued automatically by the system program	The J.NET-INT module and stations exchange information when they start up. The J.NET-INT exchanges information automatically when it is reset or powered on, according to user-set station information.
I/O service	Issued automatically by the system program	The J.NET-INT module and stations exchange I/O data. I/O communication implements automatically with a J.NET-INT I/O area being configured.
Data read service	POLLING command	The J.NET-INT module inquires whether there is a request arising from a station. This command is issued automatically by taking advantage of idle times during data communication following an exchange of initialization service information with the J.NET-INT module.
	PUT command	A station writes data to the J.NET-INT module. The data read service PUT request causes a station to write data to the J.NET-INT module after it has exchanged initialization service information with the J.NET-INT module.
	GET command	A station reads data from the J.NET-INT module. The data read service GET request causes a station to read data from the J.NET-INT module after it has exchanged initialization service information with the J.NET-INT module.
Data write service	READ command	The J.NET-INT module reads data from a station. Users can issue commands (operation functions and subroutines) as needed to read data from a station.
	WRITE command	The J.NET-INT module writes data to a station. Users can issue commands (operation functions and subroutines) as needed to write data to a station.
Reset service	Reset command	The J.NET-INT module resets a station. Users can issue commands (operation functions and subroutines) as needed to reset a station.
Broadcast service	Broadcast command	The J.NET-INT module transmits data to all the stations connected to the network. Users can issue commands (operation functions and subroutines) as needed to broadcast data to all stations.
Message write service	Not supported	Message data is written to a station. The J.NET-INT module does not support this communication service.
Message read service	Not supported	Message data is read from a station. The J.NET-INT module does not support this communication service.

The initialization service, the I/O service, the data read service PUT and GET commands, and the data write service implement automatically between the J.NET-INT module and stations when the J.NET-INT module is reset or powered on with station information being loaded in its internal parameter table.

For information on how to use the READ, WRITE, RESET and broadcast commands, see “5.6 Handlers.”

6.2 Task Start by Interrupt Input

6.2.1 Outline

The J.NET-INT module raises interrupts from DI module input signals to start preregistered interrupt tasks. The J.NET-INT module supports eight interrupt inputs for NET1 and NET2 each. Up to two units of the J.NET-INT module can be installed in the CPU unit, so that a maximum of 32 control inputs are available per CPU. J.STATIONS must be configured and interrupt tasks registered to start interrupt tasks.

6.2.2 Setting and installing the J.STATION

- **Setting station number**
Set the station number of the J.STATION to "01." If any value other than "01" is set, the task is not started and fetched as input data only.
- **Setting a station type**
Set a station type of the J.STATION to implement an I/O transfer; that is, choose one from among AUTO, I/O, I/O + DR/DW, J.STATION (EXTENDED), and J.STATION (STANDARD) (choose anything other than DR/DW). For a definition of the station types and how to set them, see "4.2.4 Editing NET1 information (Editing NET2 information)."
- **Installing the DI module**
Install the DI module of the interrupt input by the just right side of the J.STATION module. If it is installed in any other location, the task is not started but fetched as input data only. The task is started when the input signal changes from OFF into ON (from the low level into the high level).

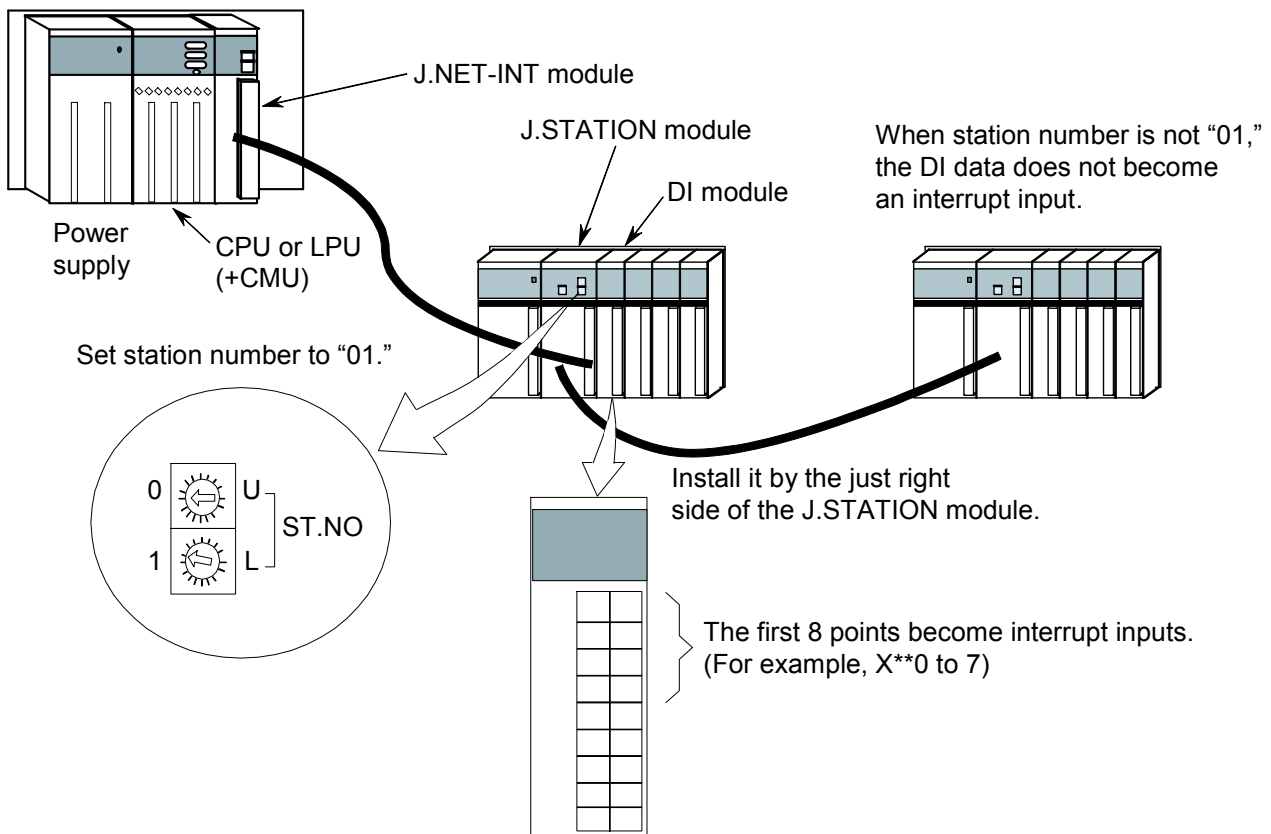

6.2.3 Interrupt task registration

Register the task numbers of the interrupt tasks that are to be started by interrupt inputs in the table shown below using the user program or the tool system MCS feature, along with the associated start factors.

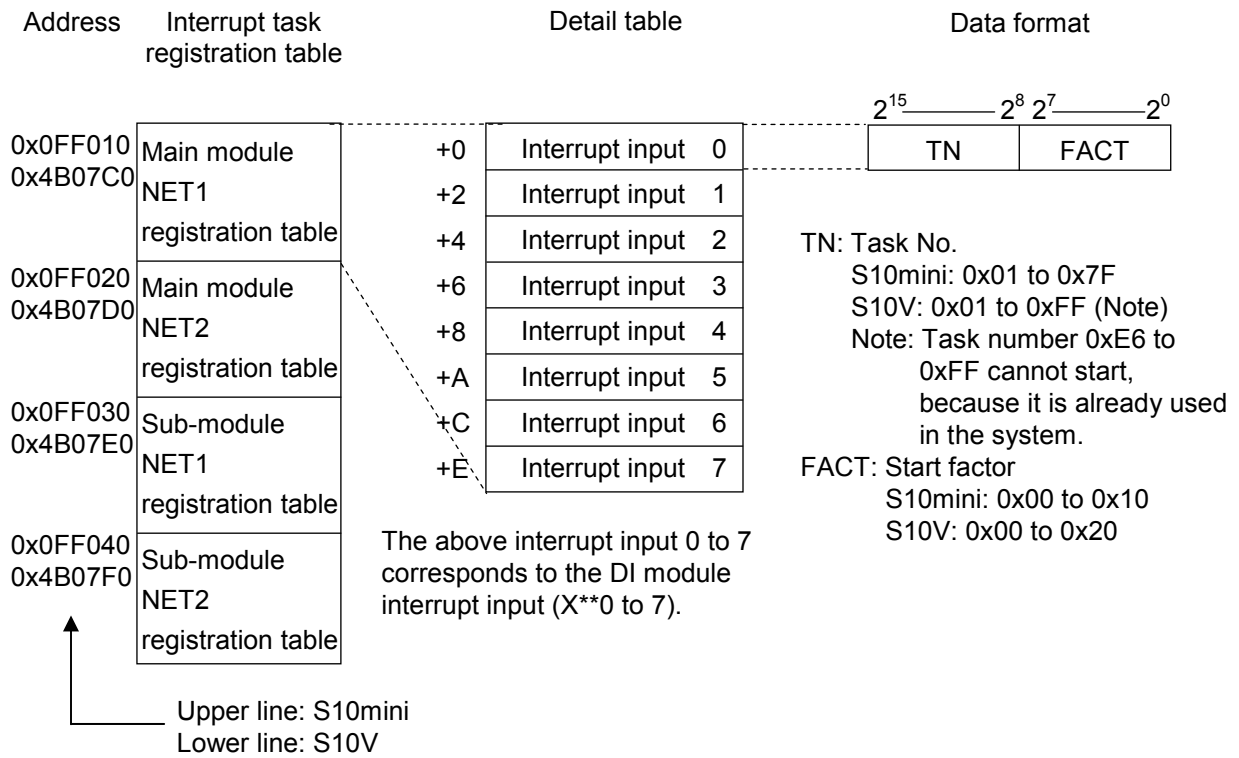

6.2.4 Starting timing

- Starting timing of interrupt task

The relation between an interrupt input and the task start timing is shown below.

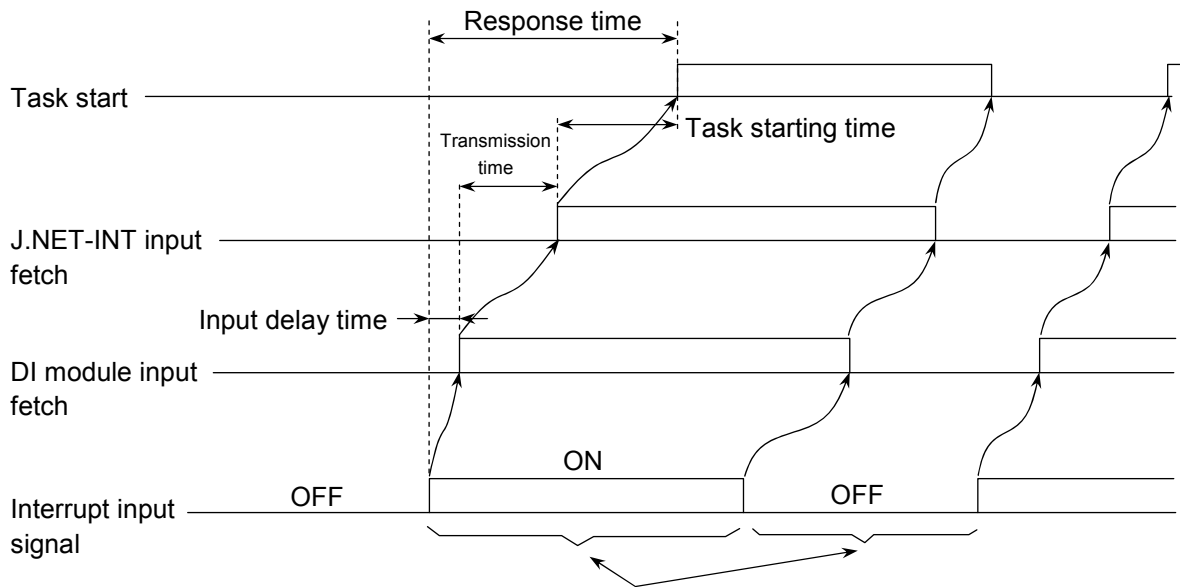

This should be kept ON longer than Input delay time + Refresh cycle.

For the interrupt input signal, an input delay time is caused by the filter of the DI module. (For the delay time due to the filter, see the specifications of each DI module.)

After the signal is fetched to the DI module as an input, it is transmitted to the J.NET-INT by cyclic communication. This transmission time is equal to the maximum refresh cycle of the J.NET-INT. Accordingly, the interrupt input should be kept ON longer (1.5 times or more) than Input delay time + Refresh cycle. If the ON time is shorter than Input delay time + Refresh cycle, the interrupt input cannot be recognized and the task may not be started.

Likewise, if the OFF time is shorter than Input delay time + Refresh cycle, the interrupt input is regarded as being kept ON and the task may not be started.

The task starting time starts the task immediately after the input is recognized. However, it varies with the task priority level and CPU program processing status.

- Releasing the interrupt task

At a task start after the interrupt input is recognized, the task is not released. Accordingly, release the interrupt task by the user program. If the interrupt task is not released by the user, the task is not started.

6.3 Communication Times

The communication time of the J.NET-INT module depends on its configuration as shown below.

- When the J.NET-INT module is connected to J.STATIONs (I/O communication only, no data transmission)

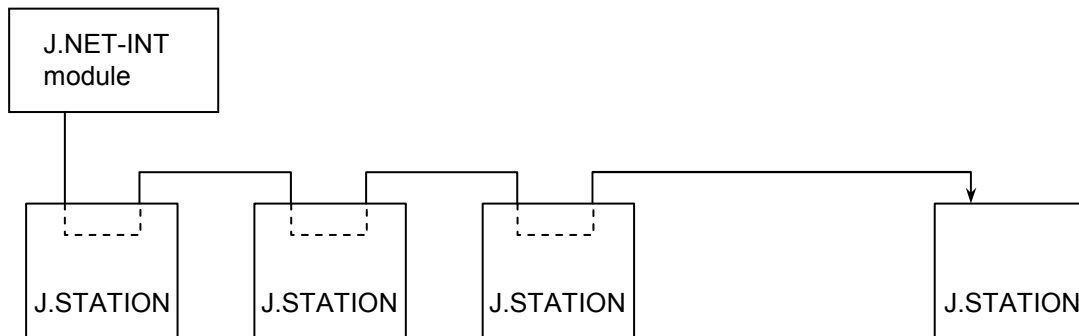

The J.STATION mounts in an I/O unit to form a remote I/O unit.

The J.NET-INT module implements I/O module data I/O (I/O service) automatically at a preset refresh cycle.

The duration of each session of I/O communication (I/O service) with a J.STATION depends on the number of I/O points that are assigned to the I/O unit.

I/O units at N points	$1.85 + 0.0031N$ [ms] (1 Mbps)
	$2.35 + 0.0054N$ [ms] (0.5 Mbps)
	$3.45 + 0.0092N$ [ms] (0.25 Mbps)
	$4.85 + 0.0176N$ [ms] (0.125 Mbps)

Set a refresh cycle that is greater than the sum total of the I/O communication times of all the J.STATIONs.

- When the J.NET-INT module is connected to J.STATIONS (data transmission available)

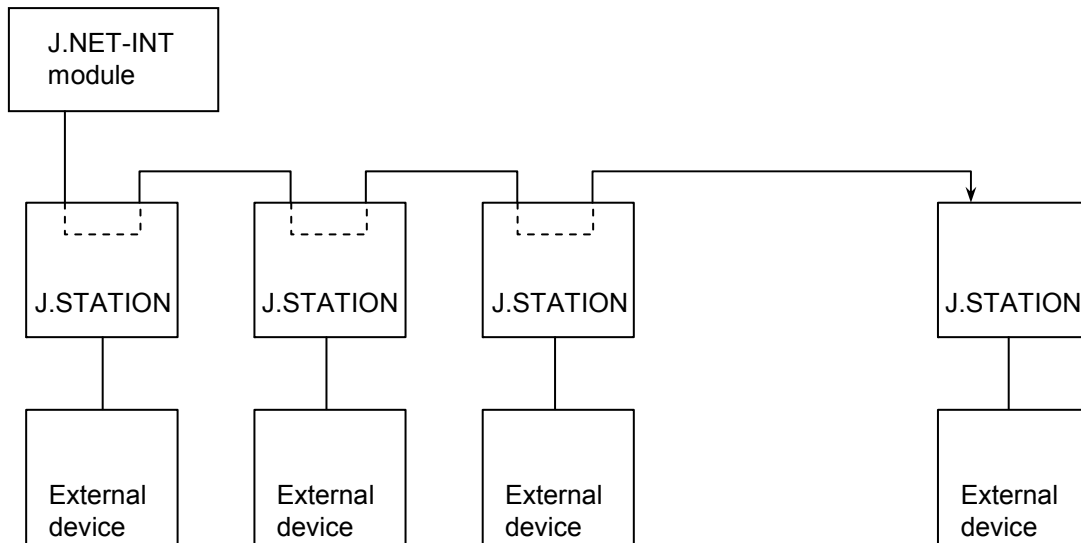

The J.STATION has an RS-232C interface to which an external device (such as a personal computer) can be attached. The duration of each session of communication with an external device can be calculated by solving the equation:

$$\text{Communication time} = A + B + C$$

A: J.NET-INT communication (I/O service + message) time

B: RS-232C communication time

C: External device communication time

The duration of each session of J.NET-INT communication (I/O service + message time) depends on the byte number of data transmitted or received in that session. It is determined by incrementing the I/O communication (I/O service) times given on the preceding page by the following times:

Transmitting N bytes of data	0.014N[ms]	1 Mbps
Receiving N bytes of data	0.025N[ms]	
Transmitting N bytes of data	0.022N[ms]	0.5 Mbps
Receiving N bytes of data	0.033N[ms]	
Transmitting N bytes of data	0.038N[ms]	0.25 Mbps
Receiving N bytes of data	0.049N[ms]	
Transmitting N bytes of data	0.067N[ms]	0.125 Mbps
Receiving N bytes of data	0.078N[ms]	

Because the J.STATION supports a buffer, slow responses of the external device connected to it would not affect the communication time of the J.NET-INT module.

This Page Intentionally Left Blank

7 MAINTENANCE

7 MAINTENANCE

7.1 Maintenance and Check

Table 7-1 Maintenance and Inspection Items

Item	Description	Frequency
Unit cleaning	Turn off all the power supplies and then vacuum the interior of the J.NET-INT module through the slits in its casing. Do not raise dust during cleaning.	Twice/year
Mechanical check	Check J.NET-INT module mounting screws, TB mounting screws, and communication cable mounting screws for looseness and damage. If a mounting screw is loose, tighten it. Replace damaged parts.	Twice/year

7.2 Troubleshooting

7.2.1 Procedure

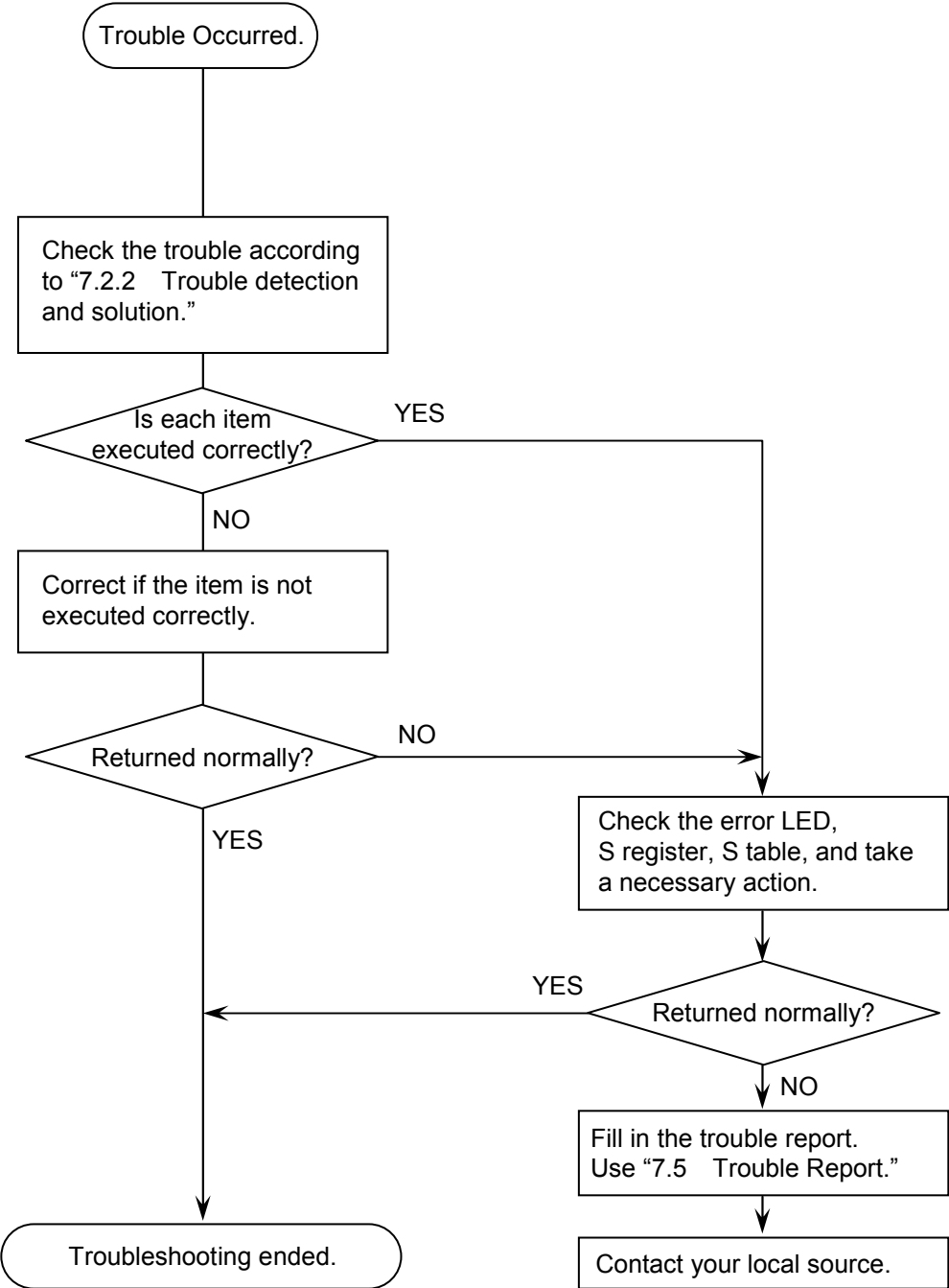

Figure 7-1 Troubleshooting Flow

7 MAINTENANCE

7.2.2 Trouble detection and solution

- Are the terminating resistors of the communication cable connected?

Terminating resistors (120 ohms) must always be connected to both ends of the communication cable line. (In J.NET-INT and J.STATION, short the TERM terminals with a jumper and thereby connect to the 120-ohm internal resistor.)

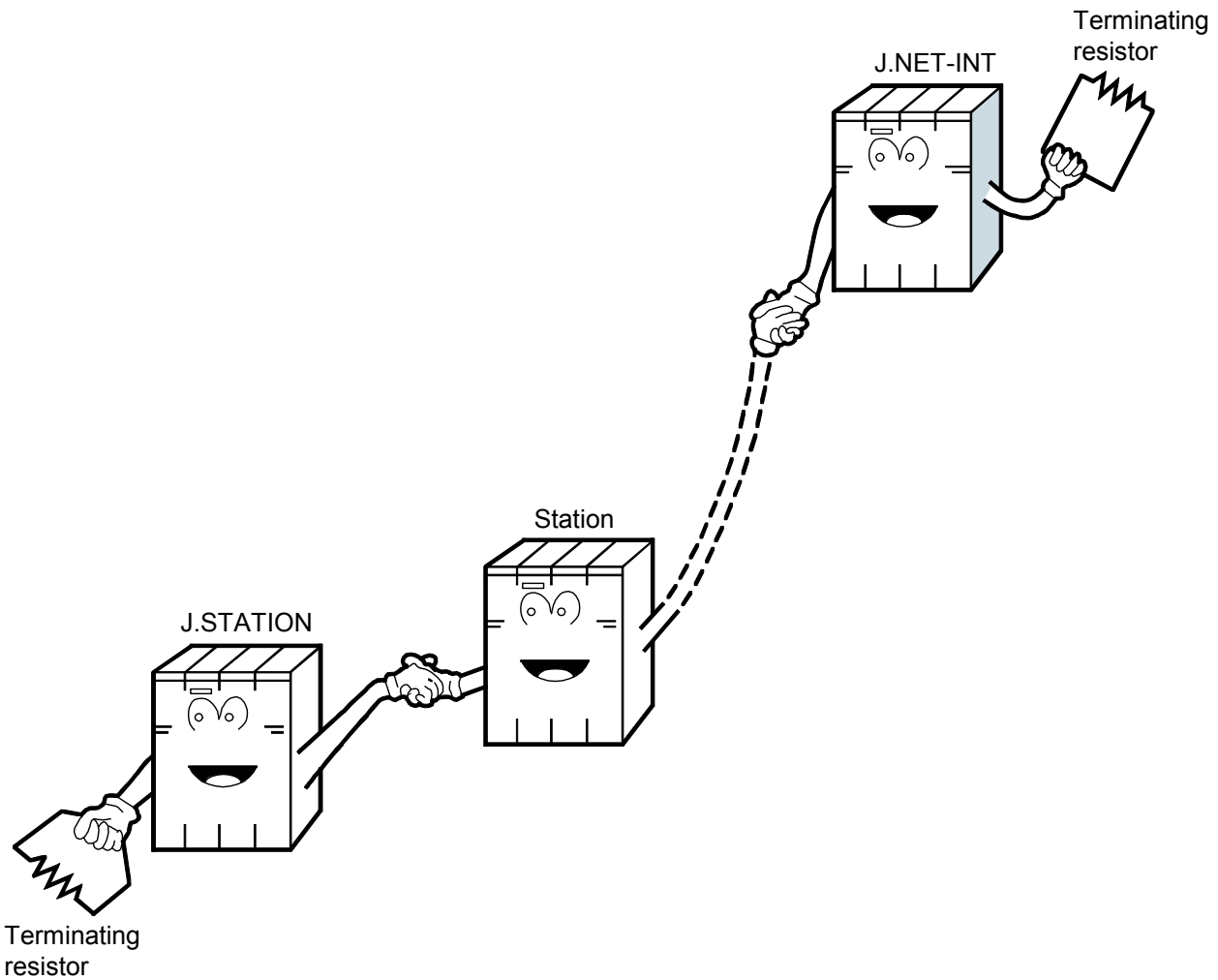

- Is the cabling correctly?

Check cables for disconnection or incorrect connection.

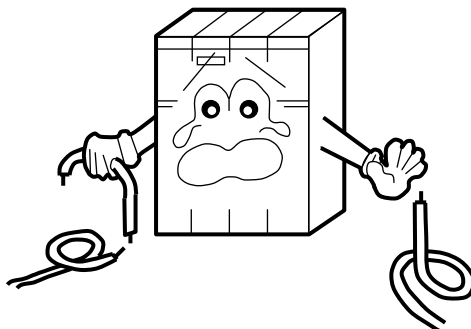

- Are the modules mounted correctly?
 - Check that the J.NET-INT module is left-justified with no idle slot between the modules.
 - Check that no set screws loosen.

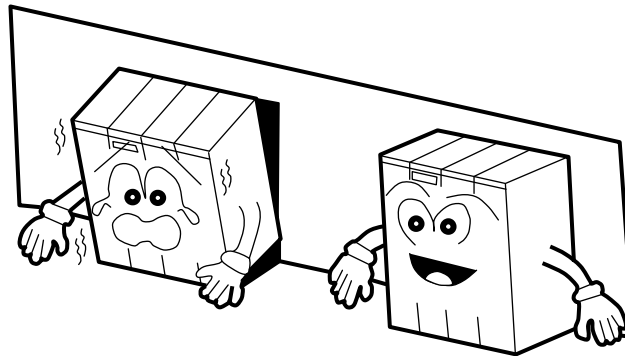

- Is grounding done correctly?
 - Do not ground the J.NET-INT module in the same place where high-voltage equipment is grounded. They must be grounded in separate places.
 - Perform grounding work conforming to class D grounding or higher.

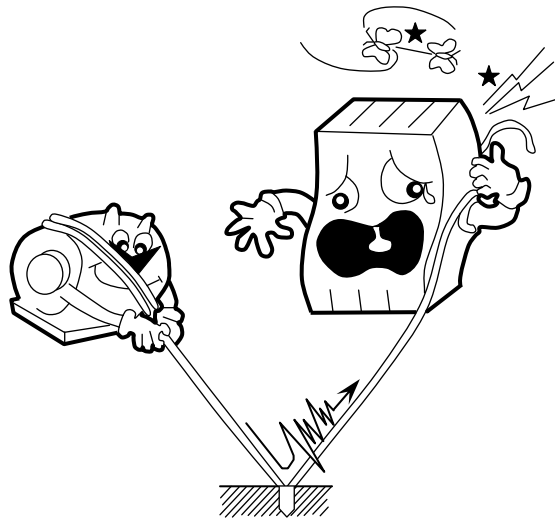

- Are LG and FG separated?
 - Be sure to separate the LG from the FG or vice versa because power noise enters the FG via the LG. Failure to observe this rule may result in an equipment malfunction.
 - Ground the LG at the power supply side.

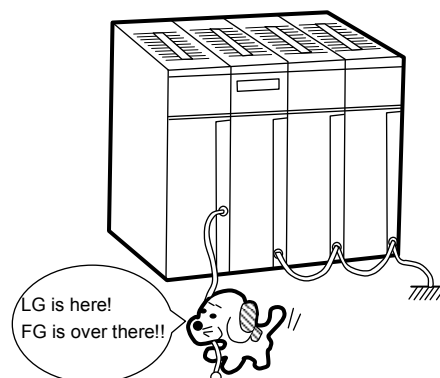

7 MAINTENANCE

7.2.3 Replacing or adding on the module

- What you should get in preparation

- ① Personal computer (with Hitachi's S10V J.NET System installed in it)
- ② RS-232C cable (or 10BASE-T cable if the communication module used is an ET.NET module)
- ③ New or add-on J.NET-INT module (LQE545)
- ④ Copies of the parameter values for the module to be replaced. (These copies are prepared for use in cases where the parameters are not accessible for some reason.)
- ⑤ The above-mentioned ET.NET module is an optional module and, if it is mounted in place, may be selected as the type of communication module to be used. For more information, refer to Section 2.1, "Names and Functions of Each Part," and Section 3.2, "Mounting the Module," in the USER'S MANUAL, OPTION ET.NET (LQE520) (manual number SVE-1-103).

- Replacement procedure

- ① Write down, on a piece of paper, the current settings of the rotary switches that are, as shown below, accessible at the front side of the J.NET-INT module to be replaced.
- ② Write down also the current settings of two switches, labeled LADDER (toggle switch) and T/M (rotary switch), respectively, that are, as shown below, accessible at the front side of the LPU module.

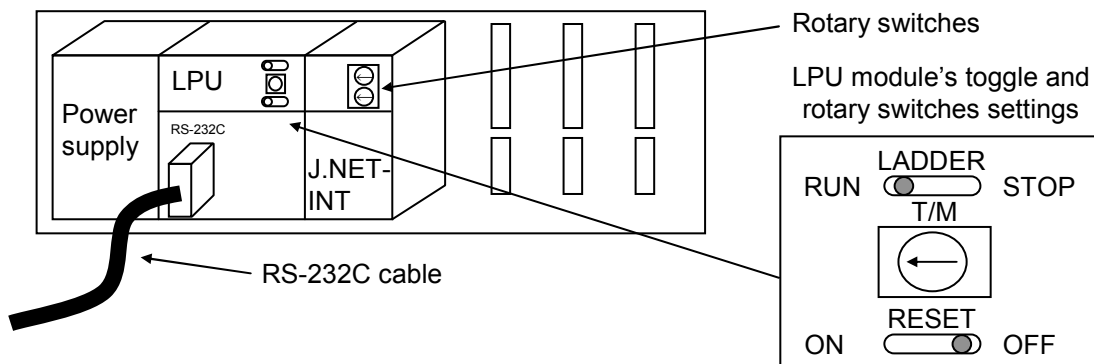

- ③ Connect the personal computer and the LPU module together with the RS-232C cable.
- ④ Start the S10V J.NET System and save the set values of all the existing parameters by using its F/D function. (If the existing parameters are not accessible for some reason, use the copies of their set values [item ④] that were obtained in preparation.)
- ⑤ Set the LPU module's LADDER switch in STOP position and turn off the power supply of the controller unit.
- ⑥ Remove the connecting cables from the J.NET-INT module to be replaced.
- ⑦ Replace the existing J.NET-INT module with the new one and set the new J.NET-INT module's rotary switches in the same way as you wrote down in Step ①.

- ⑧ Turn on the power supply of the controller unit and send to the new J.NET-INT module the set parameter values that you saved in Step ④ using the F/D function.
 - ⑨ By using the F/D function, compare the set parameter values before and after you sent. This comparison may reveal a discrepancy for the following memory areas:
 - /A3BFFE for the main J.NET-INT module mounted
 - /ABBFFE for the J.NET-INT sub-module mounted
 However, if no discrepancies are found for any other area, the set parameter values (system information) for the new J.NET-INT module may be considered as being identical between the saved file and memory.
 - ⑩ Reset the LPU module by setting the RESET switch in ON position and then in OFF position at its front.
 - ⑪ Turn off the power supply of the controller unit.
 - ⑫ Remove the RS-232C cable from both the personal computer and LPU module, which were connected together in Step ③.
 - ⑬ Connect to the new J.NET-INT module the connecting cables that you removed in Step ⑥.
 - ⑭ Set the LPU module's LADDER and T/M switches in the same way as you wrote down in Step ②.
 - ⑮ Turn on the power supply of the controller unit and check that the new J.NET-INT module is running normally.
- Add-on procedure
- ① Write down, on a piece of paper, the current settings of two switches, labeled LADDER (toggle switch) and T/M (rotary switch), respectively, that are accessible at the front side of the LPU module, the one that is installed in the controller unit in which you are adding on a J.NET-INT module.
 - ② Ensure that your application system has been shut down. Then, set the LPU module's LADDER switch in STOP position and turn off the power supply of the controller unit.
 - ③ Mount the add-on J.NET-INT module in place according to the instructions given under "3.2 Mounting the Module."
 - ④ Set the add-on J.NET-INT module's rotary switches in such a way that a new module No. setting, which must be a sub-module No. setting, will not duplicate with the current rotary switch settings of the existing main J.NET-INT module.
 - ⑤ Connect the personal computer and the LPU module together with the RS-232C cable. Then, turn on the power supply of the controller unit and set parameters for the add-on J.NET-INT module by using the S10V J.NET System.
 - ⑥ Reset the LPU module by setting the RESET switch in ON position and then in OFF position at its front.

7 MAINTENANCE

- ⑦ Turn off the power supply of the controller unit and connect the connecting cables to the add-on J.NET-INT module.
- ⑧ Set the LPU module's LADDER and T/M switches in the same way as you wrote down in Step ①.
- ⑨ Remove the RS-232C cable from both the personal computer and LPU module, which were connected together in Step ⑤.
- ⑩ Turn on the power supply of the controller unit and check that the add-on J.NET-INT module is running normally.

7.3 Errors and Countermeasures

7.3.1 Indicator display messages

In the S10mini, if an event or error occurs, such a message as shown in Table 7-2 is displayed on the indicator of the CPU module. The contents of display are distinguished between the main module and submodule of the J.NET-INT.

In the S10V, error information is collected but an error is not displayed on the LPU module. Collected error information can be referenced from the S10V system. For details, refer to “S10V USER’S MANUAL BASIC MODULE (manual number SVE-1-100).”

Table 7-2 S10mini CPU Module Display Messages

Module	Message	Description	Countermeasure
Main module	JNTM @. @	The J.NET-INT module (main module) was started normally.	This is not an error.
	EX92 PTY	A parity error was detected when the CPU read data from memory in the J.NET-INT module (main module).	If this message does not disappear even after the CPU key switch has been reset once and then set to the original position again, replace the J.NET-INT module.
	JNM □□□□	An error was detected in the J.NET-INT module (main module) board.	See “7.3.2 User action.”
	JNMN ○○○○	An error was detected in the J.NET-INT module (main module) network.	See “7.3.4 Communication errors.”
	JNMS △△△△	An error was detected in the J.NET-INT module (main module) station.	See “7.3.4 Communication errors.”
Sub-module	JNTS @. @	The J.NET-INT module (submodule) was started normally.	This is not an error.
	EX93 PTY	A parity error was detected when the CPU read data from memory in the J.NET-INT module (submodule).	If this message does not disappear even after the CPU key switch has been reset once and then set to the original position again, replace the J.NET-INT module.
	JNS □□□□	An error was detected in the J.NET-INT module (submodule) board.	See “7.3.2 User action.”
	JNSN ○○○○	An error was detected in the J.NET-INT module (submodule) network.	See “7.3.4 Communication errors.”
	JNSS △△△△	An error was detected in the J.NET-INT module (submodule) station.	See “7.3.4 Communication errors.”

@. @: J.NET-INT module version, revision

□□□□: Any of the hardware error messages explained in “7.3.2 User action”

○○○○: Any of the communication error codes explained in “7.3.4 Communication errors”

△△△△: Any of the communication error codes explained in “7.3.4 Communication errors”

7 MAINTENANCE

7.3.2 User action

When the J.NET-INT module detects an error, the S10mini displays one of the CPU displays listed in Table 7-3 in the CPU module indicator, whereas the S10V displays one of the error codes in Table 7-3 by selecting an error log from the S10V Base System. The ERR LED on the J.NET-INT module glows and error freeze information is collected at the same time. The details on error freeze information can be found in Figure 7-2. The J.NET-INT module shuts down its operation.

For information on how to start the tool system on the S10V and display error log information, refer to “S10V USER’S MANUAL BASIC MODULE (manual number SVE-1-100).”

Table 7-3 Error Contents

CPU display (S10mini)	Error code (S10V)	Contents	Action to be taken
BUS	/0010	Bus error	The J.NET-INT module may be faulty. Replace the module.
ADDR	/0011	Address error	
ILLG	/0012	Illegal instruction error	
ZERO	/0013	Division by zero error	
PRIV	/0014	Privilege violation	
WDT	/0015	WDT error	
FMAT	/0016	Format error	
SINT	/0017	Spurious interrupt	
EXCP	/0018	Unused exception	
PTY	/0019	Parity error	
MDSW	/0100	Module number switch setting error	Check the module number switch setting.
BRSW	/0101	Bit rate switch setting error	Check the bit rate switch setting.
ROM1	/0102	ROM1 sum error	The J.NET-INT module may be faulty. Replace the module.
RAM1	/0103	RAM1 compare error	
RAM2	/0105	RAM2 compare error	
ROM3	/010B	ROM3 sum error	
ROME	/010C	ROM3 erase error	
ROMW	/010E	ROM3 write error	
WOVR	/0110	ROM rewrite count over	The ROM rewrite count exceeds 50,000 times. Replace the module.
PRME	/0112	Parameter error	Set the parameter again.

NOTICE

A parameter error occurs when hardware is mounted in a different model from the model in which the parameters shown in “4.2 Commands” were set.

Concretely, there are two cases that are shown below:

Case 1: When the J.NET-INT module in which parameters were set in the S10V is installed in the S10mini, “JNM PRME” or “JNS PRME” is displayed on the CPU indicator.

Case 2: When the J.NET-INT module in which parameters were set in the S10mini is installed in the S10V, 0x0112 is displayed in the error log of the tool (S10V basic system).

The above function is intended to prevent a malfunction by referring to the parameters set in a different model.

When a checksum error occurs in the contents of parameter setting, a parameter error also occurs. When this parameter error occurs, open the parameter setting window in the mounting model and make a setting change as required.

7 MAINTENANCE

Main module	Submodule	2 ³¹ — 2 ¹⁶ 2 ¹⁵ — 2 ⁰	No.	Code	Error	
/A40400	/AC0400	Error code	1	/0010	Bus error	
/A40404	/AC0404	Time from reset (ms)	2	/0011	Address error	
		—	3	/0012	Illegal instruction error	
		—	4	/0013	Division by zero error	
/A40410	/AC0410	D0 register	5	/0014	Privilege violation	
/A40414	/AC0414	D1 register	6	/0015	WDT error	
/A40418	/AC0418	D2 register	7	/0016	Format error	
/A4041C	/AC041C	D3 register	8	/0017	Spurious interrupt	
/A40420	/AC0420	D4 register	9	/0018	Unused exception (e.g., CHK, TRAPV, L1010)	
/A40424	/AC0424	D5 register	10	/0019	Parity error	
/A40428	/AC0428	D6 register	11	/001A	Power failure forecast	
/A4042C	/AC042C	D7 register	12	/0100	Module number switch setting error	
/A40430	/AC0430	A0 register	13	/0101	Bit rate switch setting error	
/A40434	/AC0434	A1 register	14	/0102	ROM1 sum error	
/A40438	/AC0438	A2 register	15	/0103	RAM1 compare error	
/A4043C	/AC043C	A3 register	16	/0105	RAM2 compare error	
/A40440	/AC0440	A4 register	17	/0107	DMA transfer error (NET1 transmission)	
/A40444	/AC0444	A5 register	18	/0108	DMA transfer error (NET2 reception)	
/A40448	/AC0448	A6 register	19	/0109	DMA transfer error (NET1 transmission)	
/A4044C	/AC044C	A7 register	20	/010A	DMA transfer error (NET2 reception)	
/A40450	/AC0450	Stack frames (*) (4 words, 6 words, bus error)	21	/010B	ROM3 sum error	
			22	/010C	ROM erase error (Communications control program part)	
			23	/010D	ROM write error (Communications control program part)	
			24	/010E	ROM erase error (Parameter part)	
			25	/010F	ROM write error (Parameter part)	
			26	/0110	Parameter rewrite count exceeded the limit	
			27	/0112	Parameter error	
/A404FC	/AC04FC					

(*) The detail of the stack frames are shown on the next page.

Figure 7-2 Error Freeze Information

The following shows the details of the stack frames in the error freeze information table.

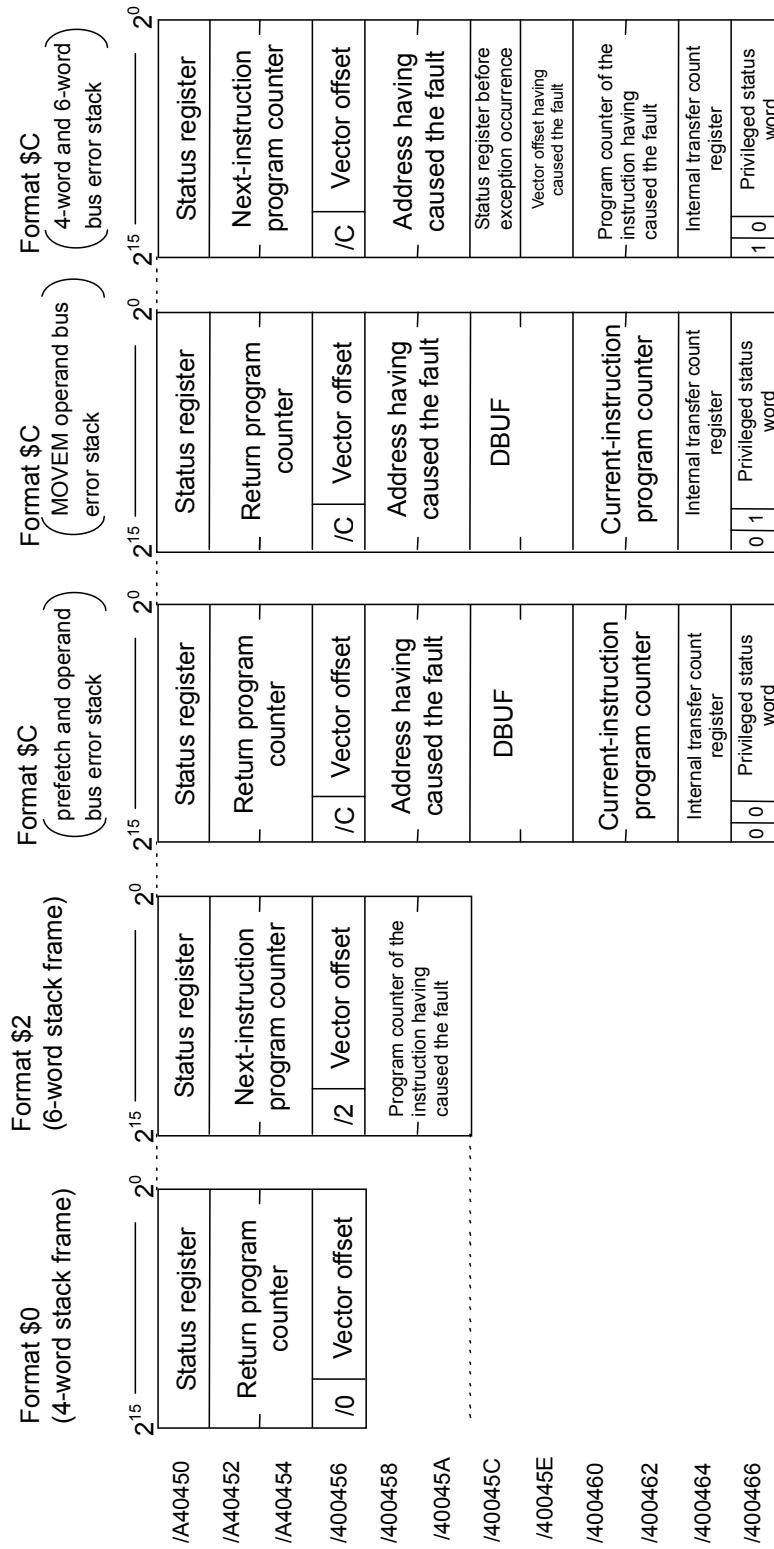

Figure 7-3 Address Map of Stack Frames

7 MAINTENANCE

7.3.3 Handler-detected error codes

When the J.NET-INT module has detected a network error, it sets error information in the S-register ALM and turns on the error flag in the NET status, and writes the corresponding error code, listed in Table 7-4, to the S-table. If the J.NET-INT module mounts in an S10mini, it displays the error code listed in Table 7-4 in the CPU module indicator. If the J.NET-INT module mounts in an S10V, it displays an error code (for example, 0xF000) that is composed of the error code listed in Table 7-4 prefixed with “0x” when an error log is selected from the tool system.

For information on how to start the tool system on the S10V and display error log information, refer to “S10V USER’S MANUAL BASIC MODULE (manual number SVE-1-100).”

Table 7-4 Handler-Detected Error Codes

Kind	Error code	Explanation	Action
Data transmission	F104	Transfer data length error	Review and correct the user program.
	F105	Station number error	Verify the SVPT entry and set it again.
	F120	Module down	Replace the J.NET-INT module.
	F130	Transmission started while starting	Review the user program and correct it to prevent new transmission starts while a transmission is already in progress.
Data reception	F204	Transfer data length error	Review and correct the user program.
	F205	Station number error	Verify the SVPT entry and set it again.
	F220	Module down	Replace the J.NET-INT module.
Command reception	F304	Transfer data length error	Review and correct the user program.
	F305	Station number error	Verify the SVPT entry and set it again.
	F320	Module down	Replace the J.NET-INT module.
	F330	Transmission started while starting	Review the user program and correct it to prevent new transmission starts while a transmission is already in progress.
	F340	Service not supported	Review the user program and correct the service code.
Response reception	F404	Transfer data length error	Review and correct the user program.
	F405	Station number error	Verify the SVPT entry and set it again.
	F420	Module down	Replace the J.NET-INT module.
	F440	Service not supported	Review the user program and correct the service code.

7.3.4 Communication errors

(1) Return code errors

When the J.NET-INT module has detected an error on a communication circuit, it sets error information in the S-register ALM and turns on the error flag in the NET status, and writes a corresponding error code to the S-table. If the J.NET-INT module mounts in an S10mini CPU, it displays the error in the CPU module indicator.

Table 7-5 Communication Error Codes

Error code	Explanation	User response
7110	An undefined service was instructed.	<ul style="list-style-type: none"> • If this error recurs even after the CPU or LPU has been reset once and then set to the original position again, restart the J.NET-INT module. • If this error still recurs, replace the J.NET-INT module.
7120	The data length is incorrect.	
7130	The packet configuration is incorrect.	
7061	A station input data fetch is not yet completed.	<ul style="list-style-type: none"> • This is not an error. • The J.NET-INT module will return to normal as soon as the data fetch is completed.
2010	An error was detected during CRC check.	<ul style="list-style-type: none"> • Check whether the network line is normal. • Check whether SVPT setting matches station setting. • If this error still recurs, replace the J.NET-INT module.
2020	The station number is from 128 to 254 or the received station number is incorrect.	
2030	An undefined service was specified.	
2040	The I-frame length is greater than or equal to 137 bytes or the UI-frame length is greater than or equal to 134 bytes.	
2041	No I-frame exists in the I-response.	
2042	An I-frame exists in the monitoring frame.	
2050	Data link procedure error	
2060	A timeout was detected (no response was made from the slave station within the specified time).	<ul style="list-style-type: none"> • Power on the station again. • Check whether the switches of the J.NET-INT module and station are set correctly. • If this error still recurs even after the switches have been set correctly, replace the station.
2061	The error could not be recovered by retry.	
2070	No frame could be transmitted to the line or an error was detected during frame reception.	<ul style="list-style-type: none"> • Check the network line connection and terminating resistor connection. • Check whether SVPT setting matches station setting. • If this error recurs even after the CPU or LPU has been reset once and then set to the original position again, restart the J.NET-INT module. • If this error still recurs, replace the J.NET-INT module.
2080	Any other error has occurred.	<ul style="list-style-type: none"> • If this error recurs even after the CPU or LPU has been reset once and then set to the original position again, restart the J.NET-INT module. • If this error still recurs, replace the J.NET-INT module.

7 MAINTENANCE

(2) Result and status errors

When an error has been detected in a station connected to the J.NET-INT module, the J.NET-INT module sets error information in the S-register ALM and turns on the error flag in the NET status, and writes a corresponding error code to the S-table. If the J.NET-INT module mounts in an S10mini CPU, it displays the error in the CPU module indicator.

Table 7-6 Station-Detected Error Codes

Error code	Explanation	User response
9001	The station is inactive.	Power on the station again and then reset the CPU. If this error still recurs, replace the station.
9002	The station is in an abnormal state. (An error was detected in the station.)	
9003	The station is inactive and also in an abnormal state.	
8020	The initialization instruction was rejected.	SVPT setting does not match station setting. Set SVPT again to match station setting. If this error still recurs, replace the station.
8081	When the AUTO mode is specified, the number of registered transfer bytes does not match the response I/O size from the station.	
8082	When a slot is specified, the number of registered transfer bytes does not match the response I/O size from the station.	

(3) Polling errors

When a station connected to the J.NET-INT module can be polled, if the J.NET-INT has detected an error while handling a PUT/GET request from the station, it sets error information in the S-register ALM and turns on the error flag in the NET status, and writes a corresponding error code to the S-table. If the J.NET-INT module mounts in an S10mini CPU, it displays the error in the CPU module indicator.

Table 7-7 Polling Error Codes

Error code	Explanation	Action
A020	Insufficient address data No corresponding symbol	Review the PUT/GET service request from the station.
A022	Address field numeric	
A021	Address field count error	
A040	Odd-numbered address	

(4) J.STATION RS-232C errors

When the J.NET-INT module has detected an error related to transmit/receive in RS-232C of J.STATION, it sets error information in the S-register ALM and turns on the error flag in the NET status, and writes a corresponding error code to the S-table.

To view error information, use the error information display function on the J.NET-INT system or the S10V J.NET-INT system.

Table 7-8 J.STATION RS-232C Error Codes

Kind	Error code	Explanation
Data transmission	B081	New transmission disabled while already transmitting. New send data cannot be transmitted since the send data that has been requested to be transmitted earlier is being transmitted (or its transmission has paused).
	B082	Transmission disabled due to no send request. Transmission is disabled since no CS (Clear To Send) input was available or DR (Data Set Ready) input was not ready when a DR check was specified.
	B083	Transmission pause timeout. Transmission paused since a transmission break code was received, but it did not resume within the send pause monitoring time because no transmission resume code came in time.
	B084	Request to send timeout. Transmission paused since CS (Clear To Send) input was lost, but it did not resume within the send monitoring time because no CS input came in time.
	B085	Data set ready timeout. Transmission paused since DR (Data Set Ready) input was lost, but it did not resume within the send monitoring time because no DR came in time.
Data reception	C080	Parity error. A parity error occurred in received data.
	C081	Overrun error. An overrun error occurred in received data.
	C082	Framing error. A framing error occurred in received data.
	C083	Receive timeout. All data could not be received within the specified receive monitoring time.
	C084	ASCII conversion error. Data other than '0' to '9' and 'A' to 'F' was received when ASCII conversion was specified.
	C085	End code error. Data other than '0' to '9' and 'A' to 'F' or data other than an end code was received when ASCII conversion was specified.
	C086	BCC error. The BCC as received did not match.
	C087	Carrier detect timeout. Reception paused since CD (carrier detect) input was lost, but it did not resume within the receive monitoring time because no CD input came in time.
	C088	Receive data overflow. Data in excess of 531 bytes was received.
C089	Data was received when the receive buffer was already full.	

7 MAINTENANCE

7.3.5 Error multiple counter

The error counter counts the communication errors that occur between the J.NET-INT module (master) and station (slave). This counter is initialized when it is reset.

[N1]	[N2]		2 ⁷ ————— 2 ⁰	
/A42000	/A42400	(At broadcast)	+00	Transmitter underrun (TXUN)
/A42020	/A42420	Station ID=01	02	CTS dissipation (TXCT)
/A42040	/A42440	Station ID=02	04	Frame length violation (RXLG)
/A42060	/A42460	Station ID=03	06	Non-octet array frame (RXNO)
/A42080	/A42480	Station ID=04	08	Abort sequence (RSAB)
/A420A0	/A424A0	Station ID=05	0A	CRC error (RXCR)
/A420C0	/A424C0	Station ID=06	0C	Overrun (RXOV)
/A420E0	/A424E0	Station ID=07	0E	CD dissipation (RXCD)
/A42100	/A42500	Station ID=08	10	Timeout (RXTO)
/A42120	/A42520	Station ID=09	12	Free (14 bytes)
/A42140	/A42540	Station ID=0A	+1E	
/A42160	/A42560	Station ID=0B		
/A42180	/A42580	Station ID=0C		
/A421A0	/A425A0	Station ID=0D		
/A421C0	/A425C0	Station ID=0E		
/A421E0	/A425E0	Station ID=0F		
/A42200	/A42600	Station ID=10		
/A42220	/A42620	Station ID=11		
/A42240	/A42640	Station ID=12		
/A42260	/A42660	Station ID=13		
/A42280	/A42680	Station ID=14		
/A422A0	/A426A0	Station ID=15		
/A422C0	/A426C0	Station ID=16		
/A422E0	/A426E0	Station ID=17		
/A42300	/A42700	Station ID=18		
/A42320	/A42720	Station ID=19		
/A42340	/A42740	Station ID=1A		
/A42360	/A42760	Station ID=1B		
/A42380	/A42780	Station ID=1C		
/A423A0	/A427A0	Station ID=1D		
/A423C0	/A427C0	Station ID=1E		
/A423E0	/A427E0	Station ID=1F		

Figure 7-4 Address Map of Error Multiple Counter

7.3.6 Trace

The J.NET-INT module traces communication status by network (N1, N2). A trace starts in error stop mode (in which the trace will stop when an error is encountered) when the CPU is reset and when power recovers from a failure, to record the status of service transmission and reception.

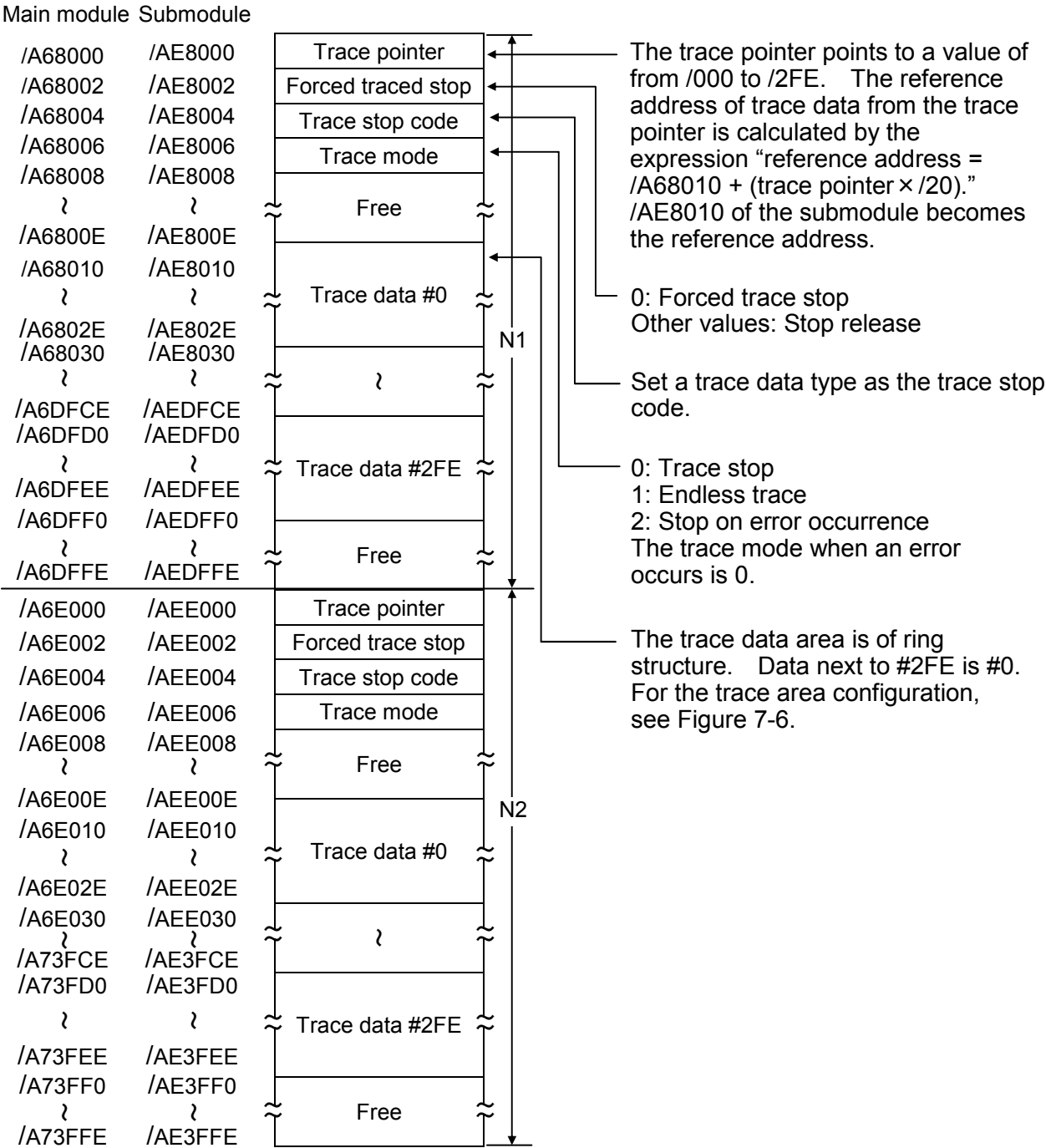

Figure 7-5 Trace Area Structure

7 MAINTENANCE

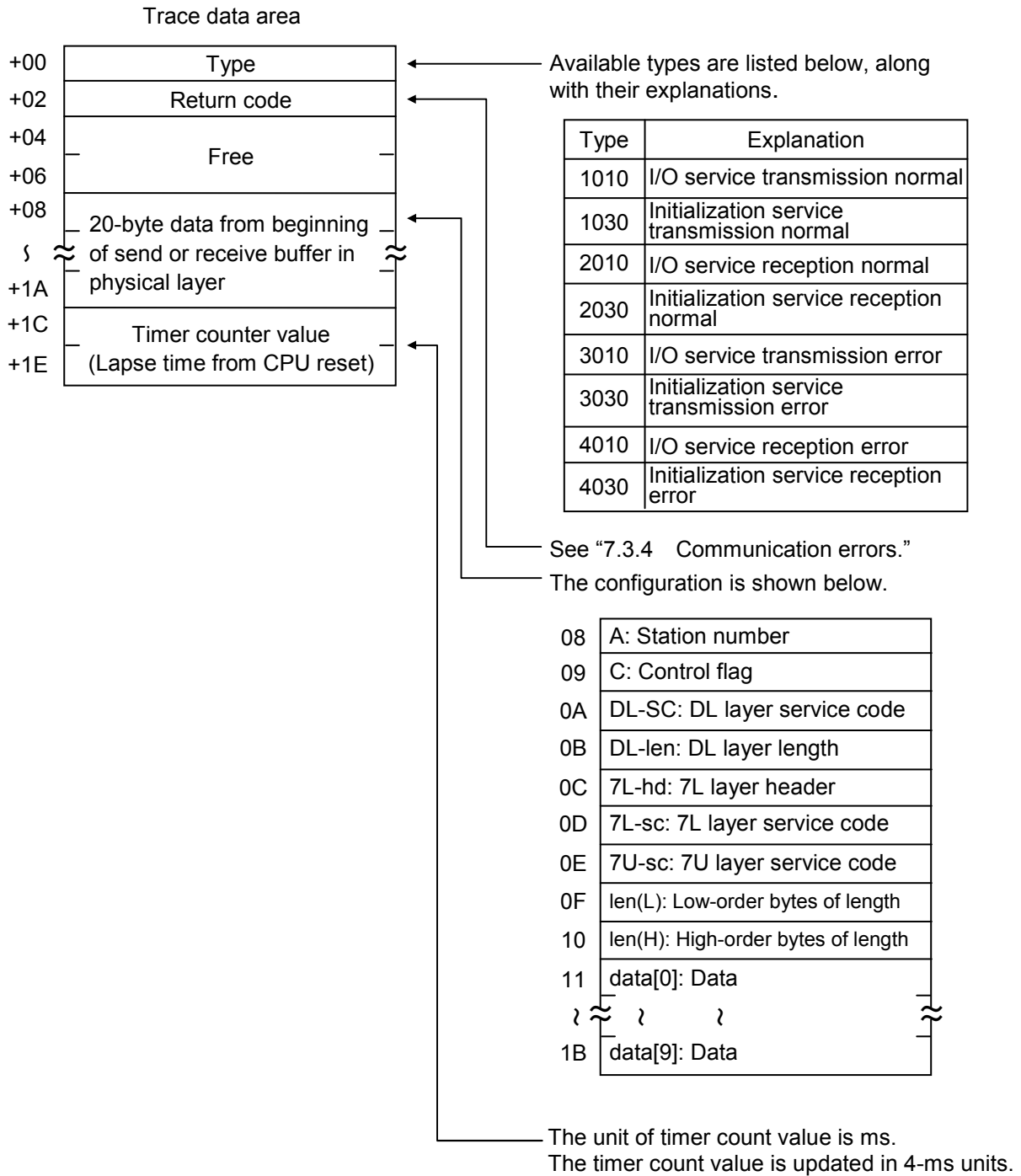

Figure 7-6 Trace Data Area Structure

7.4 Memory Map of J.NET-INT Module

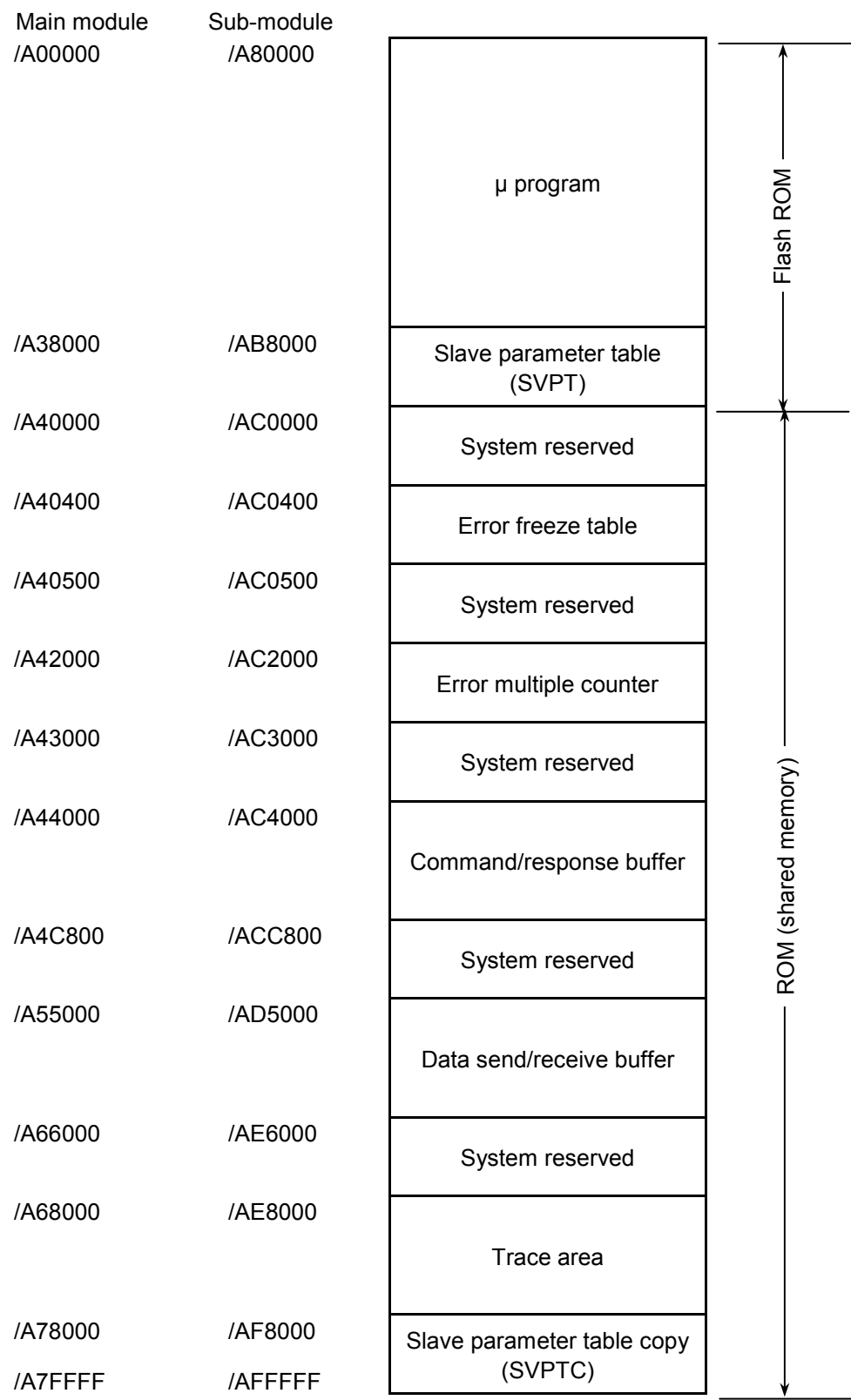

Figure 7-7 Memory Map of J.NET-INT Module

7 MAINTENANCE

7.5 Trouble Report

Fill out this form and submit it to local source.

Your company name		Person in charge	
Data and time of occurrence		(year / month / day / hour / minute)	
Where to make contact	Address		
	Telephone		
	FAX		
	E-mail		
Model of defective module		CPU/LPU model	
OS	Ver.	Rev.	Program name: Ver. Rev.
Support program		Program name: Ver. Rev.	
Symptom of defect			
Connection load	Type		
	Model		
	Wiring state		
System configuration and switch setting			
Space for correspondence			